

Approval body for construction products
and types of construction

Bautechnisches Prüfamt

An institution established by the Federal and
Laender Governments



European Technical Assessment

ETA-19/0520
of 24 May 2023

English translation prepared by DIBt - Original version in German language

General Part

Technical Assessment Body issuing the
European Technical Assessment:

Deutsches Institut für Bautechnik

Trade name of the construction product

fischer Bolt Anchor FAZ II Plus, FAZ II Plus R,
FAZ II Plus HCR

Product family
to which the construction product belongs

Mechanical fasteners for use in concrete

Manufacturer

fischerwerke GmbH & Co. KG
Klaus-Fischer-Straße 1
72178 Waldachtal
DEUTSCHLAND

Manufacturing plant

fischerwerke

This European Technical Assessment
contains

21 pages including 3 annexes which form an integral part
of this assessment

This European Technical Assessment is
issued in accordance with Regulation (EU)
No 305/2011, on the basis of

EAD 330232-01-0601 Edition 05/2021

This version replaces

ETA-19/0520 issued on 21 February 2022

The European Technical Assessment is issued by the Technical Assessment Body in its official language. Translations of this European Technical Assessment in other languages shall fully correspond to the original issued document and shall be identified as such.

Communication of this European Technical Assessment, including transmission by electronic means, shall be in full. However, partial reproduction may only be made with the written consent of the issuing Technical Assessment Body. Any partial reproduction shall be identified as such.

This European Technical Assessment may be withdrawn by the issuing Technical Assessment Body, in particular pursuant to information by the Commission in accordance with Article 25(3) of Regulation (EU) No 305/2011.

Specific Part

1 Technical description of the product

The Fischer Bolt Anchor FAZ II Plus, FAZ II Plus R, FAZ II Plus HCR is an anchor made of galvanized steel (FAZ II Plus), stainless steel (FAZ II Plus R) or high corrosion resistant steel (FAZ II Plus HCR) which is placed into a drilled hole and anchored by torque-controlled expansion.

The product description is given in Annex A.

2 Specification of the intended use in accordance with the applicable European Assessment Document

The performances given in Section 3 are only valid if the anchor is used in compliance with the specifications and conditions given in Annex B.

The verifications and assessment methods on which this European Technical Assessment is based lead to the assumption of a working life of the anchor of at least 50 years. The indications given on the working life cannot be interpreted as a guarantee given by the producer, but are to be regarded only as a means for choosing the right products in relation to the expected economically reasonable working life of the works.

3 Performance of the product and references to the methods used for its assessment

3.1 Mechanical resistance and stability (BWR 1)

Essential characteristic	Performance
Characteristic resistance to tension load (static and quasi-static loading), Method A	See Annex C1, C5 and C6
Characteristic resistance to shear load (static and quasi-static loading)	See Annex C2
Displacements	See Annex C9
Characteristic resistance and displacements for seismic performance categories C1 and C2	See Annex C7 to C9

3.2 Safety in case of fire (BWR 2)

Essential characteristic	Performance
Reaction to fire	Class A1
Resistance to fire	See Annex C3 and C4

3.3 Aspects of Durability

Essential characteristic	Performance
Durability	See Annex B1

4 Assessment and verification of constancy of performance (AVCP) system applied, with reference to its legal base

In accordance with the European Assessment Document EAD 330232-01-0601 the applicable European legal act is: [96/582/EC].

The system to be applied is: 1

5 Technical details necessary for the implementation of the AVCP system, as provided for in the applicable EAD

Technical details necessary for the implementation of the AVCP system are laid down in the control plan deposited with Deutsches Institut für Bautechnik.

Issued in Berlin on 24 May 2023 by Deutsches Institut für Bautechnik

Dipl.-Ing. Beatrix Wittstock
Head of Section

beglaubigt:
Ziegler

Cone bolt manufactured by cold - forming:

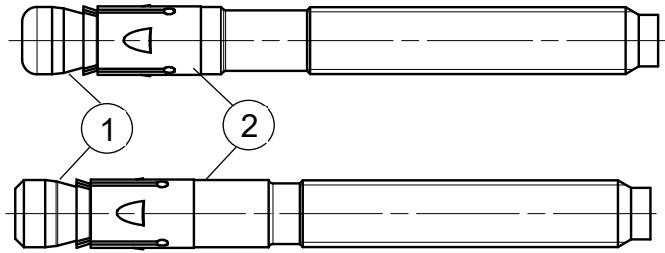

Cone bolt manufactured by turning:

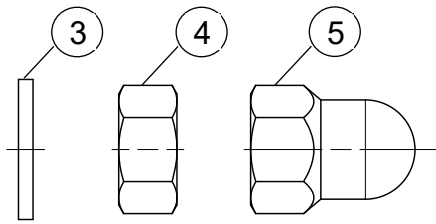

- ① Expansion sleeve
- ② Cone bolt (cold – formed or turned)
- ③ Washer
- ④ Hexagon nut
- ⑤ fischer FAZ II Plus dome nut

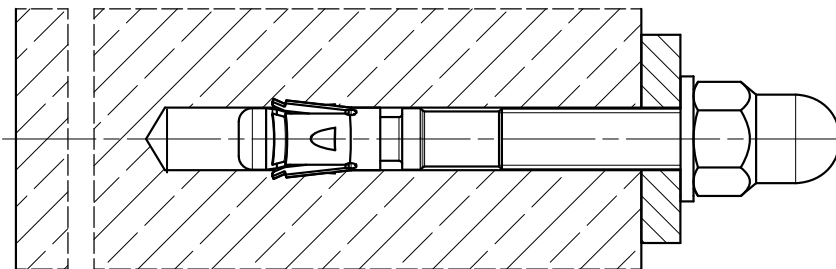
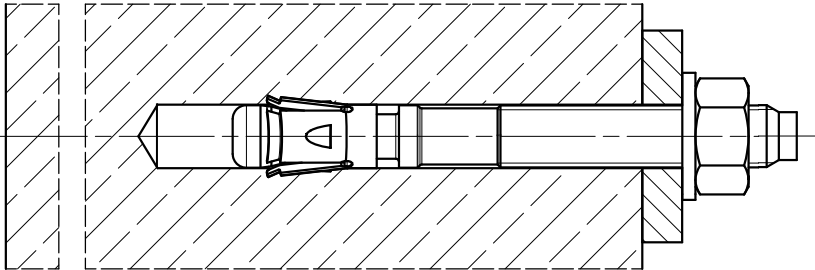

(Figure not to scale)

fischer Bolt Anchor FAZ II Plus, FAZ II Plus R,
FAZ II Plus HCR

Product description
Installed condition

Annex A1

Product marking and letter-code:

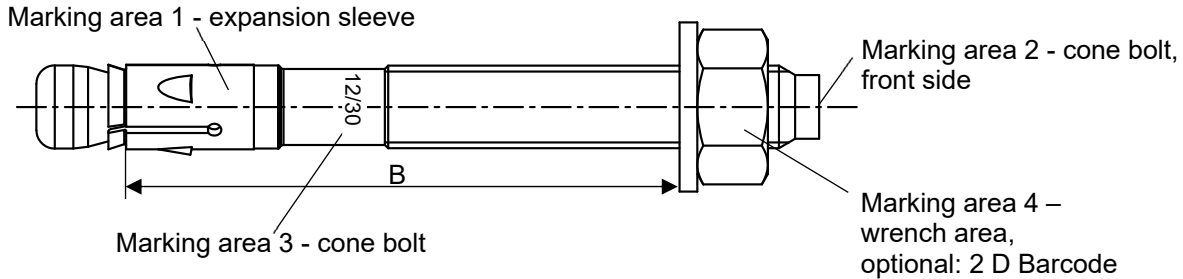

Product marking, example: FAZ II + 12/30 R

Brand | type of fastener
placed at marking area 1 or 3

Thread size / max. thickness of the fixture (t_{fix})
identification R or HCR placed at marking area 1 or 3

- FAZ II Plus: carbon steel, galvanised
- FAZ II Plus R: stainless steel
- FAZ II Plus HCR: high corrosion resistant steel

Table A2.1: Letter - code at marking area 2:

Marking	(a)	(b)	(c)	(d)	(A)	(B)	(C)	(D)	(E)	(F)	(G)	(H)	(I)	(K)
Max. t_{fix} [mm]	5	10	15	20	5	10	15	20	25	30	35	40	45	50
B ≥ [mm]	M6	-			45	50	55	60	65	70	75	80	85	90
	M8	40	45	-		50	55	60	65	70	75	80	85	90
	M10	45	50	55	60	65	70	75	80	85	90	95	100	105
	M12	55	60	65	70	75	80	85	90	95	100	105	110	115
	M16	70	75	80	85	90	95	100	105	110	115	120	125	130
	M20	-				105	110	115	120	125	130	135	140	145
	M24	-				130	135	140	145	150	155	160	165	170
Marking	(L)	(M)	(N)	(O)	(P)	(R)	(S)	(T)	(U)	(V)	(W)	(X)	(Y)	(Z)
Max. t_{fix} [mm]	60	70	80	90	100	120	140	160	180	200	250	300	350	400
B ≥ [mm]	M6	100	110	120	130	140	160	180	200	220	240	290	340	390
	M8	105	115	125	135	145	165	185	205	225	245	295	345	395
	M10	120	130	140	150	160	180	200	220	240	260	310	360	410
	M12	130	140	150	160	170	190	210	230	250	270	320	370	420
	M16	145	155	165	175	185	205	225	245	265	285	335	385	435
	M20	160	170	180	190	200	220	240	260	280	300	350	400	450
	M24	185	195	205	215	225	245	265	285	305	325	375	425	475

Calculation existing h_{ef} for installed fasteners:

$$\text{existing } h_{ef} = B_{(\text{according to table A2.1})} - \text{existing } t_{fix}$$

Thickness of the fixture t_{fix} including thickness of filling conical washer t and e.g. thickness of grout layer t_{grout} or other non-structural layers

(Figure not to scale)

fischer Bolt Anchor FAZ II Plus, FAZ II Plus R,
FAZ II Plus HCR

Product description
Product marking and letter code

Annex A2

Product dimensions

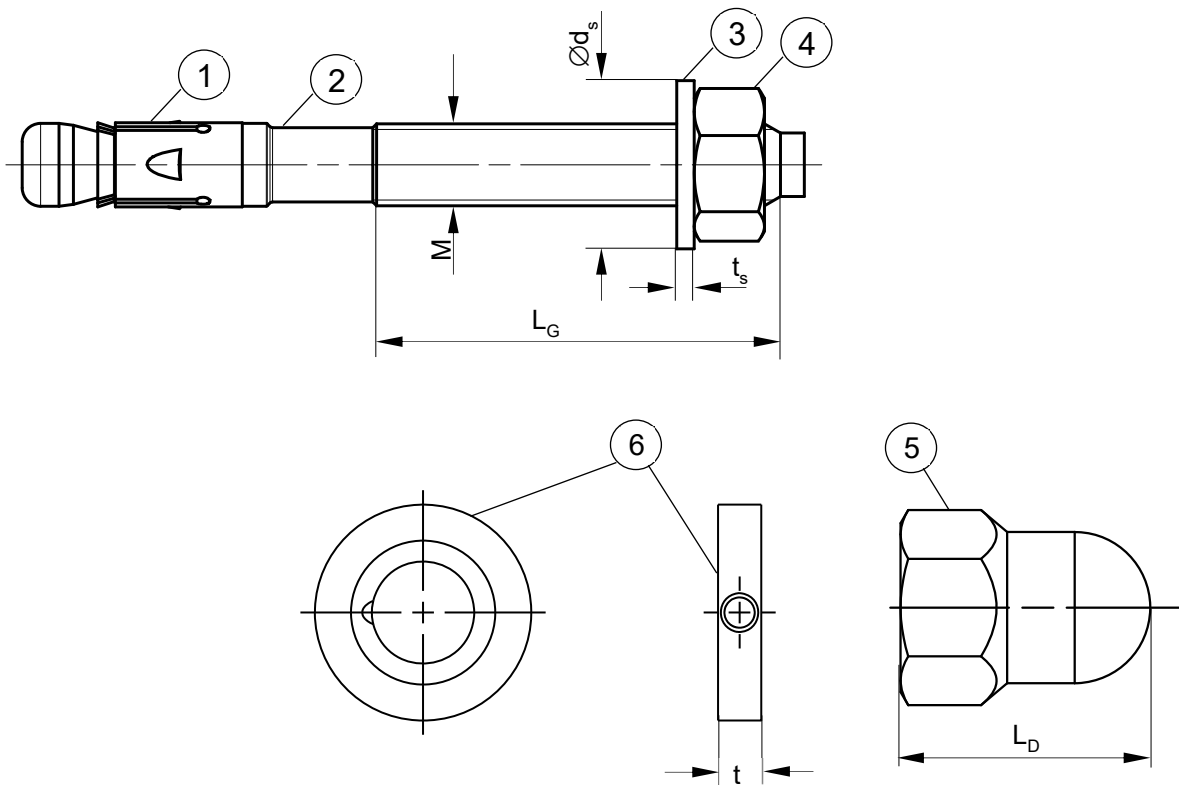

Table A3.1: Dimensions [mm]

Part	Designation	FAZ II Plus, FAZ II Plus R, FAZ II Plus HCR							
		M6	M8	M10	M12	M16	M20	M24	
1	Expansion sleeve	Sheet thickness	0,8	1,3	1,4	1,6	2,4		3,0
2	Cone bolt	Thread size M	6	8	10	12	16	20	24
		L _G	10	19	26	31	40	50	57
3	Washer	t _s	≥ 1,4		1,8	2,3	2,7		3,7
		Ø d _s	11	15	19	23	29	36	43
4 & 5	Hexagon nut / fischer FAZ II Plus dome nut	Wrench size ¹⁾	10	13	17	19	24	30	36
5		L _D	- ²⁾		22	27	33	- ²⁾	
6	fischer filling conical washer FFD	t	= 6			7	8	10	

¹⁾ Alternatively according to ISO 4032:2013 allowed

²⁾ Not part of the assessment

(Figure not to scale)



fischer Bolt Anchor FAZ II Plus, FAZ II Plus R,
FAZ II Plus HCR

Product description
Dimensions

Annex A3

Table A4.1: Materials FAZ II Plus				
Part	Designation	Material		
		FAZ II Plus	FAZ II Plus R	FAZ II Plus HCR
	Steel grade	Steel	Stainless steel R	High corrosion resistant steel HCR
		Zinc plated $\geq 5 \mu\text{m}$, ISO 4042:2018	according to EN 10088:2014 Corrosion resistance class CRC III according to EN 1993-1-4:2006+A1:2015	according to EN 10088:2014 Corrosion resistance class CRC V according to EN 1993-1-4: 2006+A1:2015
1	Expansion sleeve	Cold strip, EN 10139:2016 or stainless steel EN 10088:2014	Stainless steel EN 10088:2014	
2	Cone bolt	Cold form steel or free cutting steel	Stainless steel EN 10088:2014	High corrosion resistant steel EN 10088:2014
3	Washer	Cold strip, EN 10139:2016		
4 / 5	Hexagon nut / fischer FAZ II Plus dome nut	Steel, property class min. 8, EN ISO 898-2:2012	Stainless steel EN 10088:2014; ISO 3506-2:2020; property class – min. 70	High corrosion resistant steel EN 10088:2014; ISO 3506-2:2020; property class – min. 70
6	fischer filling conical washer FFD	Cold form steel or free cutting steel	Stainless steel EN 10088:2014	High corrosion resistant steel EN 10088:2014
fischer Bolt Anchor FAZ II Plus, FAZ II Plus R, FAZ II Plus HCR				Annex A4
Product description Materials				

Specifications of intended use

Fastenings subject to:							
Size	FAZ II Plus, FAZ II Plus R, FAZ II Plus HCR						
	M6	M8	M10	M12	M16	M20	M24
Hammer drilling with standard drill bit 	✓						
Hammer drilling with hollow drill bit with automatic cleaning 	- ¹⁾	✓					
Diamond drilling 	- ¹⁾	✓	(for non seismic applications only)				
Static and quasi-static loads	✓						
Cracked and uncracked concrete							
Fire exposure							
Seismic performance category	C1	- ¹⁾	✓				
	C2	- ¹⁾		✓			

¹⁾ No performance assessed

Base materials:

- Compacted reinforced and unreinforced normal weight concrete without fibres (cracked or uncracked) according to EN 206-1:2013+A2:2021
- Strength classes C20/25 to C50/60 according to EN 206:2013+A2:2021

Use conditions (Environmental conditions):

- Structures subject to dry internal conditions (FAZ II Plus, FAZ II Plus R, FAZ II Plus HCR)
- For all other conditions according to EN 1993-1-4:2006 + A1:2015 corresponding to corrosion resistance class
 - CRC III: for FAZ II Plus R
 - CRC V: for FAZ II Plus HCR

Design:

- Fastenings are to be designed under the responsibility of an engineer experienced in fastenings and concrete work
- Verifiable calculation notes and drawings are to be prepared taking account of the loads to be anchored. The position of the fastener is indicated on the design drawings (e.g. position of the fastener relative to reinforcement or to supports, etc.)
- Fastenings in stand-off installation or with a grout layer under seismic action are not covered
- In case of seismic applications the fastener shall be positioned outside of critical regions (e.g. plastic hinges) of the concrete structure
- Design of fastenings according to EN 1992-4:2018 and EOTA Technical Report TR 055:2018

fischer Bolt Anchor FAZ II Plus, FAZ II Plus R, FAZ II Plus HCR	Annex B1
Intended Use Specifications	

Table B2.1: Installation parameters

Size	FAZ II Plus, FAZ II Plus R, FAZ II Plus HCR						
	M6	M8	M10	M12	M16	M20	M24
Nominal drill hole diameter $d_0 =$	6	8	10	12	16	20	24
Maximum bit diameter with hammer or hollow drilling $d_{cut,max}$ [mm]	6,40	8,45	10,45	12,5	16,5	20,55	24,55
Maximum bit diameter with diamond drilling	- ¹⁾	8,15		12,25	16,45	20,50	24,40
Effective embedment depth $h_{ef} \geq$	40-80	35-90	40-100	50-125	65-160	100-180	125
Length from h_{ef} to end of cone bolt L	6,5	9,5	11,5	13,5	17,5	20,0	23,5
Overall fastener embedment depth in the concrete $h_{nom} \geq$ [mm]	$h_{ef} + L$						
Depth of drill hole to deepest point $h_1^{2)} \geq$	$h_{nom} + 3$		$h_{nom} + 5$		$h_{nom} + 10$		
Diameter of clearance hole in the fixture $d_f \leq$ [mm]	7	9	12	14	18	22	26
Required setting torque $T_{inst} =$ [Nm]	8	20	45	60	110	200	270
Excess length after hammering-in the cone bolt (for fischer dome nut applications according to Annex B4) $O =$ [mm]	- ¹⁾		12	16	20	- ¹⁾	

¹⁾ Not part of the assessment

²⁾ For the application without drill hole cleaning: $h_{1,nc} = h_1 + 15$ mm

Setting gauge FAZ II Plus SL-H
for fastener with fischer FAZ II Plus dome nut:

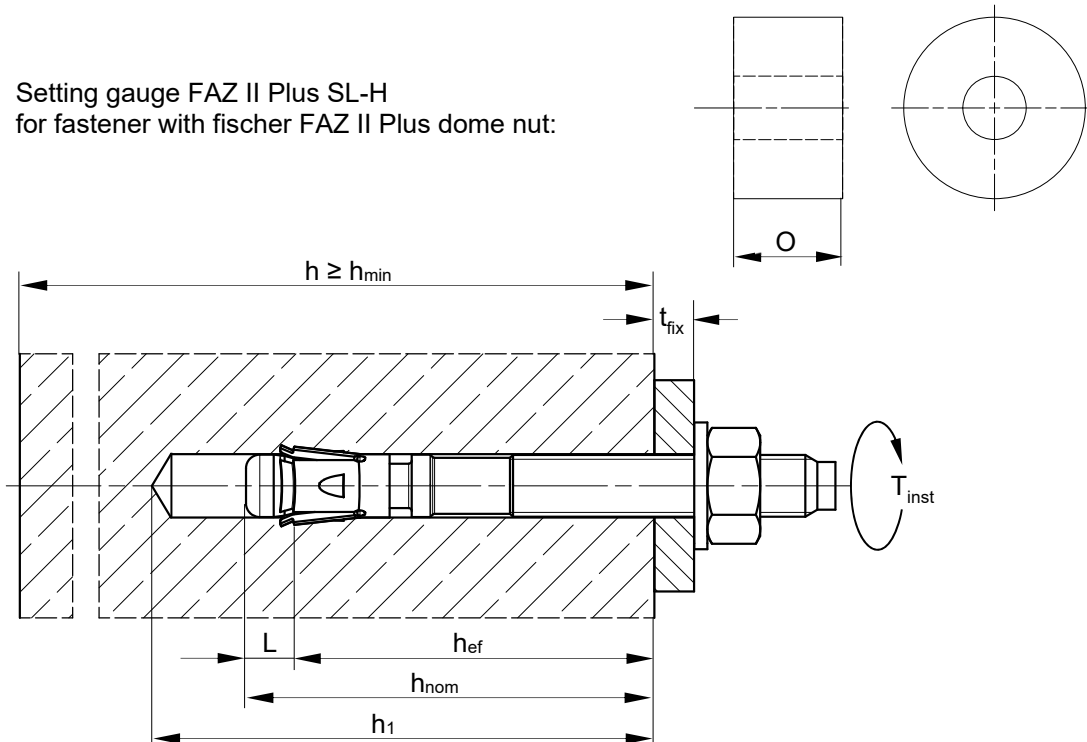

h_{ef} = Effective embedment depth
 h_{nom} = Overall fastener embedment depth in the concrete
 h_1 = Depth of drill hole to deepest point
 $h_{1,nc}$ = Depth of drill hole to deepest point without cleaning
 L = Length from h_{ef} to end of cone bolt

h = Thickness of the concrete member
 h_{min} = Minimum thickness of concrete member
 t_{fix} = Thickness of the fixture
 O = Length of setting gauge
 T_{inst} = Required setting torque

fischer Bolt Anchor FAZ II Plus, FAZ II Plus R,
FAZ II Plus HCR

Intended Use
Installation parameters







Annex B2

Installation instructions:

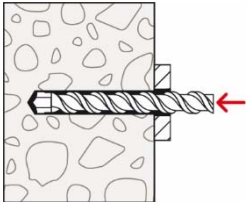
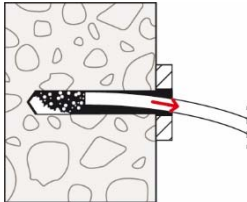
- Fastener installation carried out by appropriately qualified personnel according to the design drawings and under the supervision of the person responsible for technical matters on the site
- Use of the fastener only as supplied by the manufacturer without exchanging the components of the fastener
Exception: fischer FAZ II Plus dome nut
- Hammer, hollow or diamond drilling according to Annex B1 + B2
- Drill hole created perpendicular +/- 5° to concrete surface, positioning without damaging the reinforcement
- In case of aborted hole: new drilling at a minimum distance twice the depth of the aborted drill hole or smaller distance if the aborted drill hole is filled with high strength mortar and if under shear or oblique tension load it is not in the direction of load application

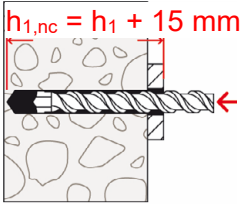
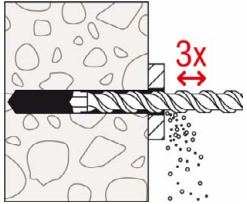
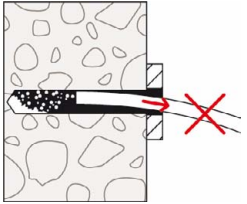
Installation instructions: Drilling and cleaning the hole

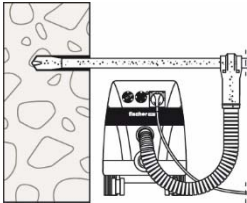
Types of drills and cleaning

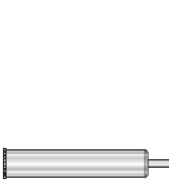
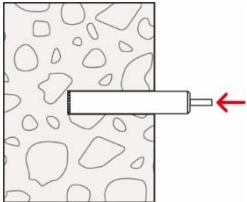
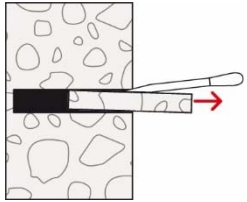
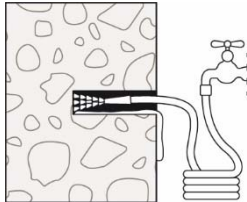
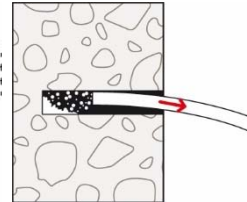
<p>Hammer drill (e.g. fischer Quattric II) with cleaning</p>		 <p>1: Drill the hole</p>	 <p>2: Clean the hole</p>	<p>Continue with step 5</p>	
<p>Hammer drill (e.g. fischer Quattric II) without cleaning</p>		 <p>1: Drill the hole</p> <p>$h_{1,nc} = h_1 + 15 \text{ mm}$</p>	 <p>2: When $h_{1,nc}$ is reached: Pull out drill 3 x</p>	 <p>Cleaning not necessary; Continue with step 5</p>	
<p>Hollow drill (e.g. fischer FHD)</p>		 <p>1: Drill the hole with automatic cleaning (e.g. fischer FVC)</p>	 <p>Cleaning obsolete</p>	<p>Continue with step 5</p>	
<p>Diamond drill, for non seismic applications only</p>		 <p>1: Drill the hole</p>	 <p>2: Break the drill core and remove it</p>	 <p>3: Flush the drill hole, until clear water emerges from the drill hole</p>	 <p>4: Clean the hole</p>

fischer Bolt Anchor FAZ II Plus, FAZ II Plus R, FAZ II Plus HCR

Intended Use
Installation instructions

Annex B3

Installation instructions: Installation of the fastener

HEXAGON NUT:

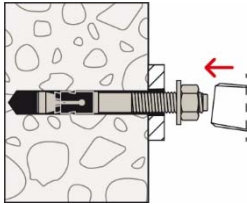

5.a: Set the fastener
e.g. with hammer

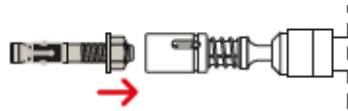

5.b: Set the fastener
e.g. fischer FA-ST II

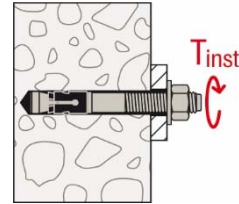

6: Apply T_{inst}

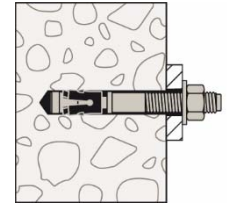

7: Installed fastener

fischer FAZ II Plus DOME NUT:

Option 1: Push through installation with setting gauge SL-H:

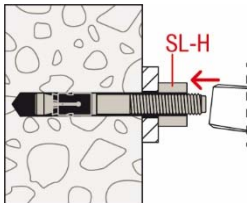

5.1: Set the fastener
through the set-
ting gauge and
fixture

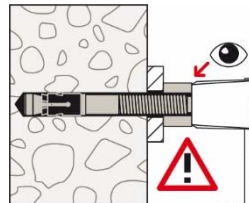

5.2: Check offset

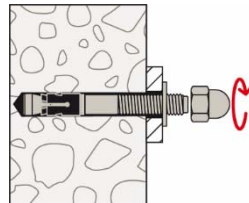

5.3: Turn on the
fischer FAZ II
Plus dome nut

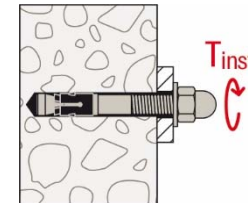

6: Apply T_{inst}

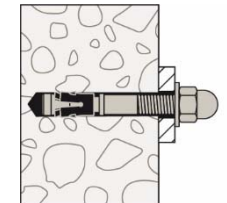

7: Installed fastener

Option 2: Push through installation with hexagon nut:

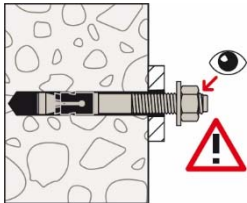

5.1: Check setting
position: Visible
one turn of a
thread

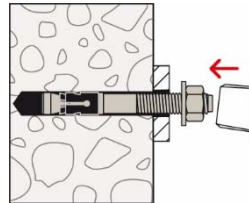

5.2: Set the fastener

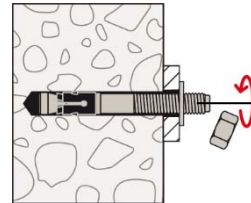

5.3: Remove nut

fischer Filling conical washer FFD optional for seismic C2 application or minimising the annular gap:

Optional

The gap between bolt and fixture may be filled with mortar (compressive strength $\geq 50 \text{ N/mm}^2$ e.g. fischer FIS SB) after last step (for eliminating the annular gap). The FFD is additional to the standard washer. The thickness of the FFD must be considered for definition of t_{fix} . Countersunk of the FFD in direction to the anchor plate. Installation with hexagon nut or dome nut is permitted.

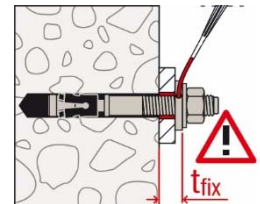
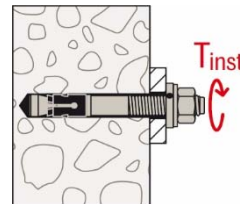
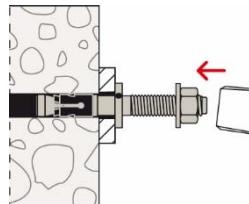
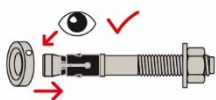

fischer Bolt Anchor FAZ II Plus, FAZ II Plus R,
FAZ II Plus HCR

Intended Use
Installation instructions

Annex B4

Table C1.1: Characteristic values of **tension** resistance under static and quasi-static action

Size		FAZ II Plus, FAZ II Plus R, FAZ II Plus HCR								
		M6	M8	M10	M12	M16	M20	M24		
Steel failure										
Characteristic resistance	FAZ II Plus	$N_{Rk,s}$ [kN]	11,3	19,9	32,7	49,3	78,7	108,4	180,0	
	FAZ II Plus R		12,1	21,0	34,5	52,0	83,0	127,6	187,0	
	FAZ II Plus HCR		11,3	17,6	29,1	43,8	69,9			
Partial factor for steel failure	FAZ II Plus	$\gamma_{Ms}^{1)}$ [-]	1,4				1,4	1,5		
	FAZ II Plus R						1,45			
	FAZ II Plus HCR		1,5	1,45	1,4	1,5				
Pullout failure										
Effective embedment depth for calculation	h_{ef} [mm]	40-80	40 ³⁾ - < 45	45-90	40-100	50-125	65-160	100-180	125	
Characteristic resistance in cracked concrete C20/25	$N_{Rk,p}$ (C20/25) [kN]	1,5	5,5	8	13	20	27,0	34,4	48,1	
Characteristic resistance in uncracked concrete C20/25		10,5	14	20	22	38,6	49,2	68,8		
Increasing factor ψ_c for cracked or uncracked concrete $N_{Rk,p} = \psi_c \cdot N_{Rk,p}$ (C20/25)	[-]	C25/30	1,12							
		C30/37	1,22							
		C35/45	1,32							
		C40/50	1,41							
		C45/55	1,50							
C50/60	1,58									
Installation sensitivity factor	γ_{inst} [-]	1,0								
Concrete cone and splitting failure										
Factor for uncracked concrete	$k_{ucr,N}$ [-]	11,0 ²⁾								
Factor for cracked concrete	$k_{cr,N}$ [-]	7,7 ²⁾								
Characteristic spacing	$s_{cr,N}$ [mm]	$3 \cdot h_{ef}$								
Characteristic edge distance	$c_{cr,N}$ [mm]	$1,5 \cdot h_{ef}$								
Characteristic spacing for splitting failure	$s_{cr,sp}$ [mm]	$2 \cdot c_{cr,sp}$								
Characteristic edge distance for splitting failure h	$c_{cr,sp}$ [mm]	40	≥ 80	$2,4 \cdot h_{ef}$	$2 \cdot h_{ef}$	- ⁵⁾				
			≥ 100	$2 \cdot h_{ef}$	$2,4 \cdot h_{ef}$					$2 \cdot h_{ef}$
			≥ 120		$2,1 \cdot h_{ef}$					
			≥ 140	$1,9 \cdot h_{ef}$	$1,5 \cdot h_{ef}$					$2 \cdot h_{ef}$
			≥ 160		$2 \cdot h_{ef}$					$2,4 \cdot h_{ef}$
≥ 200	$2,2 \cdot h_{ef}$									
Characteristic resistance to splitting	$N^0_{Rk,sp}$ [kN]	$\min \{N^0_{Rk,c}; N_{Rk,p}\}^{4)}$								

¹⁾ In absence of other national regulations

²⁾ Based on concrete strength as cylinder strength

³⁾ For dry internal exposure and statically indeterminate redundant components, the minimum effective embedment depth can be reduced to 35 mm without reduction of $N_{Rk,p}$.

⁴⁾ $N^0_{Rk,c}$ according to EN 1992-4:2018

⁵⁾ No performance assessed

fischer Bolt Anchor FAZ II Plus, FAZ II Plus R, FAZ II Plus HCR

Performances
Characteristic values of tension resistance under static and quasi-static action

Annex C1

Table C2.1: Characteristic values of **shear** resistance under static and quasi-static action

Size		FAZ II Plus, FAZ II Plus R, FAZ II Plus HCR							
		M6	M8	M10	M12	M16	M20	M24	
Steel failure without lever arm									
Characteristic resistance	FAZ II Plus without filling of the annular gap	7,5	16,3	26,2	37,0	68,4	82,9	128,3	
	FAZ II Plus with filling		18,1	27,3	40,7	69,8	85,6		
	FAZ II Plus without filling R	8,8	17,6	26,5	42,1	71,1	107,9	158,1	
	FAZ II Plus with filling R			27,6	44,3	73,6	117,9		
	FAZ II Plus without filling HCR		17,4	27,9	23,7	42,1	71,1		107,9
	FAZ II Plus with filling HCR				27,9	42,1	73,6		117,9
Partial factor for steel failure	$\gamma_{Ms}^{1)}$	1,25							
Factor for ductility	k_7	1,0							
Steel failure with lever arm and Concrete pryout failure									
Effective embedment depth for calculation	h_{ef} [mm]	40-80	45-90	60-100	70-125	85-160	100-180	125	
Characteristic bending resistance	FAZ II Plus	11	30	60	105	266	422	864	
	FAZ II Plus R		29	59	100	256	519	898	
	FAZ II Plus HCR								
Factor for pryout failure	k_8 [-]	2,6	2,8	3,2					
Effective embedment depth for calculation	h_{ef} [mm]	- ²⁾	40 ³⁾ - < 45	40 - < 60	50 - < 70	65 - < 85	- ²⁾		
Characteristic bending resistance	FAZ II Plus		27	56	105	251			
	FAZ II Plus R		29	59	100	256			
	FAZ II Plus HCR		24	50		223			
Factor for pryout failure	k_8 [-]	2,5	2,6	3,1	3,2				
Partial factor for steel failure	$\gamma_{Ms}^{1)}$	1,25							
Factor for ductility	k_7	1,0							
Concrete edge failure									
Effective embedment depth for calculation	l_f [mm]	h_{ef}							
Outside diameter of a fastener	d_{nom} [mm]	6	8	10	12	16	20	24	
<p>1) In absence of other national regulations</p> <p>2) No performance assessed</p> <p>3) For dry internal exposure and statically indeterminate redundant components, the minimum effective embedment depth can be reduced to 35 mm without reduction of $N_{RK,p}$.</p>									
fischer Bolt Anchor FAZ II Plus, FAZ II Plus R, FAZ II Plus HCR							Annex C2		
Performances Characteristic values of shear resistance under static and quasi-static action									

Table C3.1: Characteristic values of tension resistance under fire exposure

Size		FAZ II Plus, FAZ II Plus R, FAZ II Plus HCR														
		M6		M8		M10		M12		M16		M20		M24		
		$h_{ef} \geq$ [mm]		40	35	45	40	60	50	70	65	85	100	125		
Characteristic resistance steel failure	FAZ II Plus	$N_{Rk,s,fi}$	R30	0,6 ¹⁾ / 0,9 ²⁾		1,4	2,8		5,0		9,4		14,7		21,1	
			R60	0,4 ¹⁾ / 0,9 ²⁾		1,2	2,3		4,1		7,7		12,0		17,3	
			R90	0,3 ¹⁾ / 0,9 ²⁾		0,9	1,9		3,2		6,0		9,4		13,5	
			R120	0,2 ¹⁾ / 0,7 ²⁾		0,8	1,6		2,8		5,2		8,1		11,6	
	FAZ II Plus R / HCR	$N_{Rk,s,fi}$	R30	0,6 ¹⁾ / 0,9 ²⁾		3,6	7,8		11,5		21,8		34,3		49,4	
			R60	0,4 ¹⁾ / 0,9 ²⁾		2,3	4,8		7,1		13,2		20,7		29,3	
			R90	0,3 ¹⁾ / 0,9 ²⁾		1,9	3,8		5,7		10,5		18,3		26,4	
			R120	0,2 ¹⁾ / 0,7 ²⁾		1,6	3,3		4,9		8,6		17,3		25,0	
			$7,7 \cdot h_{ef}^{1,5} \cdot (20)^{0,5} \cdot h_{ef} / 200 / 1000$													
			$7,7 \cdot h_{ef}^{1,5} \cdot (20)^{0,5} \cdot h_{ef} / 200 / 1000 \cdot 0,8$													
Characteristic resistance Concrete cone failure	$N_{Rk,c,fi}$	R30														
		- R90														
		R120														
		$7,7 \cdot h_{ef}^{1,5} \cdot (20)^{0,5} \cdot h_{ef} / 200 / 1000 \cdot 0,8$														
Characteristic resistance pullout failure	$N_{Rk,p,fi}$	R30	0,4	0,9												
		R60		0,8	2,0	2,2	3,3	3,0	5,0	4,5	6,8	8,6	12,0			
		R90		0,5												
		R120	0,3		1,6	1,7	2,6	2,4	4,0	3,6	5,4	6,9	9,6			

Table C3.2: Characteristic values of shear resistance under fire exposure

FAZ II Plus			R30		R60	
			$V_{Rk,s,fi,30}$ [kN]	$M^0_{Rk,s,fi,30}$ [Nm]	$V_{Rk,s,fi,60}$ [kN]	$M^0_{Rk,s,fi,60}$ [Nm]
M6	40	$h_{ef} \geq$ [mm]	0,6 ¹⁾ / 0,9 ²⁾	0,5 ¹⁾ / 0,2 ²⁾	0,4 ¹⁾ / 0,9 ²⁾	0,3 ¹⁾ / 0,1 ²⁾
M8	35		1,8	1,4	1,6	1,2
M10	40		3,6	3,6	2,9	3,0
M12	50		6,3	7,8	4,9	6,4
M16	65		11,7	19,9	9,1	16,3
M20	100		18,2	39,0	14,2	31,8
M24	125		26,3	67,3	20,5	55,0
FAZ II Plus			R90		R120	
			$V_{Rk,s,fi,90}$ [kN]	$M^0_{Rk,s,fi,90}$ [Nm]	$V_{Rk,s,fi,120}$ [kN]	$M^0_{Rk,s,fi,120}$ [Nm]
M6	40	0,3 ¹⁾ / 0,9 ²⁾	0,2 ¹⁾ / 0,1 ²⁾	0,2 ¹⁾ / 0,7 ²⁾	0,2 ¹⁾ / 0,1 ²⁾	
M8	35	1,3	1,0	1,2	0,8	
M10	40	2,2	2,4	1,9	2,1	
M12	50	3,5	5,0	2,8	4,3	
M16	65	6,6	12,6	5,3	11,0	
M20	100	10,3	24,6	8,3	21,4	
M24	125	14,8	42,6	11,9	37,0	

Concrete pryout failure according to EN 1992-4:2018

¹⁾ FAZ II Plus

²⁾ FAZ II Plus R / FAZ II Plus HCR

fischer Bolt Anchor FAZ II Plus, FAZ II Plus R,
FAZ II Plus HCR

Performances
Characteristic values of resistance under fire exposure

Annex C3

Table C4.1: Characteristic values of shear resistance under fire exposure

FAZ II Plus R, FAZ II Plus HCR		R30		R60	
		$V_{Rk,s,fi,30}$ [kN]	$M^0_{Rk,s,fi,30}$ [Nm]	$V_{Rk,s,fi,60}$ [kN]	$M^0_{Rk,s,fi,60}$ [Nm]
M6	40	0,6 ¹⁾ / 0,9 ²⁾	0,5 ¹⁾ / 0,2 ²⁾	0,4 ¹⁾ / 0,9 ²⁾	0,3 ¹⁾ / 0,1 ²⁾
M8	35	3,6	3,7	2,3	2,4
M10	40	7,8	10,1	4,8	6,2
M12	50	11,5	17,9	7,1	11,1
M16	65	21,8	46,2	13,2	27,9
M20	100	34,3	90,9	20,7	54,9
M24	125	49,4	157,2	29,3	93,1

FAZ II Plus R, FAZ II Plus HCR		R90		R120	
		$V_{Rk,s,fi,90}$ [kN]	$M^0_{Rk,s,fi,90}$ [Nm]	$V_{Rk,s,fi,120}$ [kN]	$M^0_{Rk,s,fi,120}$ [Nm]
M6	40	0,3 ¹⁾ / 0,9 ²⁾	0,2 ¹⁾ / 0,1 ²⁾	0,2 ¹⁾ / 0,7 ²⁾	0,2 ¹⁾ / 0,1 ²⁾
M8	35	1,9	1,9	1,6	1,7
M10	40	3,8	4,9	3,3	4,3
M12	50	5,7	8,8	4,9	7,6
M16	65	10,5	22,1	8,6	18,3
M20	100	18,3	48,6	17,3	45,9
M24	125	26,4	84,0	25,0	79,4

¹⁾ FAZ II Plus

²⁾ FAZ II Plus R / FAZ II Plus HCR

Concrete pryout failure according to EN 1992-4:2018

Table C4.2: Minimum spacings and minimum edge distances of fasteners under fire exposure for tension and shear load

Size	FAZ II Plus, FAZ II Plus R, FAZ II Plus HCR						
	M6	M8	M10	M12	M16	M20	M24
Spacing s_{min}	Annex C5						
Edge distance c_{min} [mm]	$c_{min} = 2 \cdot h_{ef}$, for fire exposure from more than one side $c_{min} \geq 300$ mm						

fischer Bolt Anchor FAZ II Plus, FAZ II Plus R,
FAZ II Plus HCR

Performances
Characteristic values of resistance under fire exposure

Annex C4

Table C5.1: Minimum thickness of concrete members, minimum spacing and minimum edge distance

Size	FAZ II Plus, FAZ II Plus R, FAZ II Plus HCR							
	M6	M8	M10	M12	M16	M20	M24	
Minimum edge distance								
Uncracked concrete	40	40	45	55	65	95	135	
Cracked concrete						85	100	
Corresponding	s [mm] according to Annex C6							
Minimum thickness of concrete member	80		100	140	160	200		
Thickness of concrete member	h ≥ max. {h _{min} ; 1,5 · h _{ef} ; h ₁ ¹⁾ + 25}			max. {h _{min} ; 1,5 · h _{ef} ; h ₁ ¹⁾ + 30}				
Minimum spacing								
Uncracked concrete	35	40	40	50	65	95	100	
Cracked concrete		35						
Corresponding	c [mm] according to Annex C6							
Minimum thickness of concrete member	80		100	140	160	200		
Thickness of concrete member	h ≥ max. {h _{min} ; 1,5 · h _{ef} ; h ₁ + 25}			max. {h _{min} ; 1,5 · h _{ef} ; h ₁ + 30}				
Minimum splitting area								
Uncracked concrete	A _{sp,req} [-1000 mm ²]	5,1	18	37	54	67	100	117,5
Cracked concrete		1,5	12	27	40	50	77	87,5

¹⁾ If borehole cleaning is omitted, h₁ is replaced by h_{1,nc}

Table C5.2: Minimum spacing and minimum edge distances - calculated values for **cracked concrete with one edge** (c₂ and c₃ ≥ 1,5 c₁)

Type of anchor / size	FAZ II Plus, FAZ II Plus R, FAZ II Plus HCR											
	M6	M8	M10	M12	M16	M20	M24					
Effective anchorage depth	h _{ef} ≥ [mm]	40	35	45	40	60	50	70	65	85	100	125
Minimum thickness of concrete member	h ¹⁾ ≥ [mm]	80		85	80	120	100	140	140	180	160	200
Minimum spacing	S _{min} [mm]	35		40	50	65	95	100				
	for c ≥ [mm]	40		100	65	120	80	100	75	130	115	
Minimum edge distance	C _{min} [mm]	40		60	45	70	55	65	85	100		
	for s ≥ [mm]	35		160	90	190	125	165	85	230	140	

¹⁾ thickness of concrete member has to be increased by 15 mm, if borehole cleaning is omitted

fischer Bolt Anchor FAZ II Plus, FAZ II Plus R, FAZ II Plus HCR

Performances
Minimum thickness of member, minimum spacing and edge distances

Annex C5

Determination of $A_{sp,ef}$ for each existing free edge

Splitting failure applied for minimum edge distance and spacing in depending on h_{ef}

Definition Index:

cal = calculatory

e.g.: $s_{x,y}$

x = load direction

y = number anchor plate

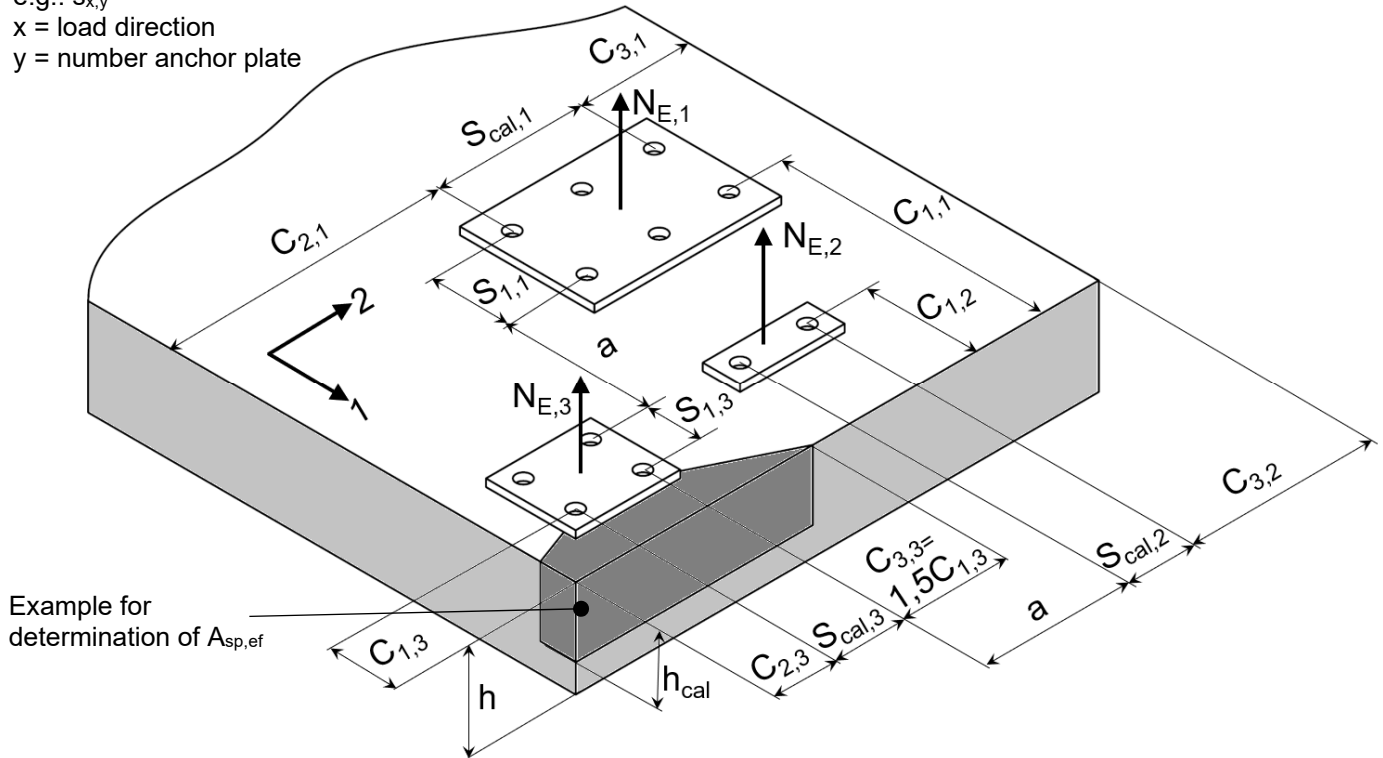

Example for determination of $A_{sp,ef}$

Example for different anchor plates: For considering all free edges the direction 1 and 2 must be swapped.

General formulation for each free edge: $A_{sp,ef} = (C_2 + S_{cal} + C_3) \cdot h_{cal} \geq (n/2) \cdot A_{sp,req}$

with:

Edge distance c_1 : $c_{min} \leq C_1$

Edge distance c_2 : $c_{min} \leq C_2 \leq 1,5 \cdot C_1$

Edge distance c_3 : $c_{min} \leq C_3 \leq 1,5 \cdot C_1$

Calculation spacing, distance between outer anchors s_{cal} : $s_{min} \leq S_{cal} \leq 3,0 \cdot C_1$

Distance between group of anchors a: For $a \geq 3,0 \cdot C_1$ no influence between the anchor groups is taken into account.

Number of anchors n of an anchor plate as well close and parallel to the edge

Effective member thickness h_{cal} : $h_{min} \leq h$; $h_{cal} \leq h$; $h_{cal} \leq (h_{ef} + 1,5 \cdot C_1)$

C_1, C_2, C_3, h and s_{cal} have to be set in way that the requirement is fulfilled

For the calculation of minimum spacing and minimum edge distance of fasteners in combination with different embedment depths and thicknesses of concrete members the following equation shall be fulfilled:

$$A_{sp,req} < A_{sp,ef}$$

$A_{sp,req}$ = required splitting area (according to Annex C 5)

$A_{sp,ef}$ = effective splitting area

(Figure not to scale)

fischer Bolt Anchor FAZ II Plus, FAZ II Plus R,
FAZ II Plus HCR

Performances

Minimum thickness of member, minimum spacings and edge distances

Annex C6

Table C7.1: Characteristic values of tension and shear resistance under seismic action category C1

Size		FAZ II Plus, FAZ II Plus R, FAZ II Plus HCR									
		M6	M8		M10	M12	M16	M20	M24		
Effective embedment depth	h_{ef} [mm]	- 2)	40 - <45	45- 90	40-100	50-125	85-160	100-180	125		
With filling of the annular gap	α_{gap} [-]		1,0								
Without filling of the annular gap			0,5								
Steel failure $N_{Rk,s,C1} = N_{Rk,s}$; $\gamma_{Ms,C1} = \gamma_{Ms}$ (see Annex C1)											
Pullout failure											
Characteristic resistance in cracked concrete C1	$N_{Rk,p,C1}$ [kN]	- 2)	5,1	7,4	11,6	20,0	27,0	34,4	48,1		
Installation sensitivity factor	γ_{inst} [-]		1,0								
Concrete cone failure and splitting failure $N_{Rk,c,C1} = N_{Rk,c}$; $N_{Rk,sp,C1} = N_{Rk,sp}$ (see Annex C1)											
Steel failure without lever arm											
FAZ II Plus											
Characteristic resistance C1	h_{ef} [mm]	- 2)	45-90	60-100	70-125	85-160	100-180	125	102,6		
	Without filling		$V_{Rk,s,C1}$ [kN]	14,8	23,6	33,3	58,1	71,2			
	With filling		$V_{Rk,s,C1}$ [kN]	16,5	24,6	39,9	59,3	85,6			
	h_{ef} [mm]		- 2)	40-<45	40-<60	50-<70	- 2)				
	Without filling			$V_{Rk,s,C1}$ [kN]	- 2)						32,9
	With filling			$V_{Rk,s,C1}$ [kN]	15,6	19,7					39,9
	FAZ II Plus R										
	Characteristic resistance C1	h_{ef} [mm]	- 2)	45-90	60-100	70-125	85-160	100-180	125	126,5	
		Without filling		$V_{Rk,s,C1}$ [kN]	16,0	23,9	37,9	60,4	86,3		
		With filling		$V_{Rk,s,C1}$ [kN]	24,8	43,4	62,6	94,3			
		h_{ef} [mm]		- 2)	40-<45	40-<60	50-<70	- 2)			
		Without filling			$V_{Rk,s,C1}$ [kN]	- 2)					
With filling		$V_{Rk,s,C1}$ [kN]			15,1	19,9	43,4				
FAZ II Plus HCR											
Characteristic resistance C1	h_{ef} [mm]	- 2)	45-90	60-100	70-125	85-160	100-180	125	126,5		
	Without filling		$V_{Rk,s,C1}$ [kN]	15,8	21,3	37,9	60,4	86,3			
	With filling		$V_{Rk,s,C1}$ [kN]	25,1	41,3	62,6	94,3				
	h_{ef} [mm]		- 2)	40-<45	40-<60	50-<70	- 2)				
	Without filling			$V_{Rk,s,C1}$ [kN]	- 2)						37,5
	With filling			$V_{Rk,s,C1}$ [kN]	15,0	20,1					41,3
Partial factor for steel failure	$\gamma_{Ms,C1}^{1)}$ [-]	1,25									
<p>¹⁾ In absence of other national regulations</p> <p>²⁾ No performance assessed</p>											
fischer Bolt Anchor FAZ II Plus, FAZ II Plus R, FAZ II Plus HCR								Annex C7			
Performances Characteristic values of tension and shear resistance under seismic action category C1											

Table C8.1: Characteristic values of tension and shear resistance under seismic action category C2

Size	FAZ II Plus, FAZ II Plus R, FAZ II Plus HCR										
	M6	M8	M10	M12	M16	M20	M24				
With filling of the annular gap	α_{gap}	[-]	-2)	1,0							
Without filling of the annular gap				0,5							
Steel failure $N_{Rk,s,C2} = N_{Rk,s}$; $\gamma_{Ms,C2} = \gamma_{Ms}$ (see Annex C1)											
Pullout failure											
Characteristic resistance in cracked concrete C2	h_{ef}	[mm]	-2)	60-100	70-125	85-160	100-180	125			
	$N_{Rk,p,C2}$	[kN]		5,1	7,4	21,5	30,7	39,6			
	h_{ef}	[mm]		40 - <60	50 - <70	65 - <85	-2)				
	$N_{Rk,p,C2}$	[kN]		2,7	4,4	16,4					
Installation sensitivity factor	γ_{inst}	[-]		1,0							
Concrete cone failure and splitting failure $N_{Rk,c,C2} = N_{Rk,c}$; $N_{Rk,sp,C2} = N_{Rk,sp}$ (see Annex C1)											
Steel failure without lever arm											
Characteristic resistance C2	FAZ II Plus										
	h_{ef}	[mm]	-2)	60-100	70-125	85-160	100-180	125			
	Without filling	$V_{Rk,s,C2}$		[kN]	17,6	27,8	37,6	62,2	70,6		
	With filling	$V_{Rk,s,C2}$		[kN]	20,5	30,5	52,4	68,5	102,6		
	h_{ef}	[mm]		40 - <60	50 - <70	65 - <85	-2)				
	Without filling	$V_{Rk,s,C2}$		[kN]	14,1	24,4	31,2				
	With filling	$V_{Rk,s,C2}$		[kN]	14,7	30,5	52,4				
	FAZ II Plus R										
	h_{ef}	[mm]		-2)	60-100	70-125	85-160	100-180	125		
	Without filling	$V_{Rk,s,C2}$			[kN]	17,8	31,6	39,1	70,5	87,0	
	With filling	$V_{Rk,s,C2}$			[kN]	20,7	33,2	55,2	104,9	126,5	
	h_{ef}	[mm]			40 - <60	50 - <70	65 - <85	-2)			
	Without filling	$V_{Rk,s,C2}$			[kN]	14,3	27,8	32,4			
	With filling	$V_{Rk,s,C2}$			[kN]	14,9	33,2	55,2			
	FAZ II Plus HCR										
	h_{ef}	[mm]			-2)	60-100	70-125	85-160	100-180	125	
	Without filling	$V_{Rk,s,C2}$				[kN]	15,9	31,6	39,1	70,5	87,0
	With filling	$V_{Rk,s,C2}$				[kN]	20,9		55,2	104,9	126,5
	h_{ef}	[mm]				40 - <60	50 - <70	65 - <85	-2)		
	Without filling	$V_{Rk,s,C2}$				[kN]	12,8	27,8	32,4		
	With filling	$V_{Rk,s,C2}$				[kN]	15,1	31,6	55,2		
	Partial factor for steel	$\gamma_{Ms,C2}^{1)}$				[-]		1,25			
	1) In absence of other national regulations										
	2) No performance assessed										
fischer Bolt Anchor FAZ II Plus, FAZ II Plus R, FAZ II Plus HCR							Annex C8				
Performances Characteristic values of resistance under tension and shear loads under seismic action category C2											

Table C9.1: Displacements under static and quasi static tension loads

Size	FAZ II Plus, FAZ II Plus R, FAZ II Plus HCR						
	M6	M8	M10	M12	M16	M20	M24
Displacement – factor for tensile load¹⁾							
δ_{N0} - factor in cracked concrete	0,13	0,22	0,12	0,09	0,08	0,07	0,05
$\delta_{N\infty}$ - factor	1,00	0,78	0,40	0,19	0,09		0,07
δ_{N0} - factor in uncracked concrete	0,16	0,07	0,05	0,06		0,05	0,04
$\delta_{N\infty}$ - factor	0,24	0,29	0,21	0,14	0,10	0,06	0,05

Table C9.2: Displacements under static and quasi static shear loads

Size	FAZ II Plus, FAZ II Plus R, FAZ II Plus HCR						
	M6	M8	M10	M12	M16	M20	M24
Displacement – factor for shear load²⁾							
FAZ II Plus							
δ_{V0} - factor	0,6	0,35	0,37	0,27	0,10	0,09	0,07
$\delta_{V\infty}$ - factor	0,9	0,52	0,55	0,40	0,14	0,15	0,11
FAZ II Plus R, FAZ II Plus HCR							
δ_{V0} - factor	0,6	0,23	0,19	0,18	0,10	0,11	0,07
$\delta_{V\infty}$ - factor	0,9	0,35	0,29	0,27	0,15	0,17	0,11

¹⁾ Calculation of effective displacement:

$$\delta_{N0} = \delta_{N0} - \text{factor} \cdot N$$

$$\delta_{N\infty} = \delta_{N\infty} - \text{factor} \cdot N$$

N = Action tension loading

²⁾ Calculation of effective displacement:

$$\delta_{V0} = \delta_{V0} - \text{factor} \cdot V$$

$$\delta_{V\infty} = \delta_{V\infty} - \text{factor} \cdot V$$

V = Action shear loading

Table C9.3: Displacements under tension loads for category C2 for all embedment depths

Size	FAZ II Plus, FAZ II Plus R, FAZ II Plus HCR						
	M6	M8	M10	M12	M16	M20	M24
DLS $\delta_{N,C2(DLS)}$ [mm]	- ¹⁾		2,7	4,4		5,6	4,8
ULS $\delta_{N,C2(ULS)}$ [mm]	- ¹⁾		11,5	13,0	12,3	14,4	15,2

¹⁾ No performance assessed

Table C9.4: Displacements under shear loads for category C2 for all embedment depths

Size	FAZ II Plus, FAZ II Plus R, FAZ II Plus HCR						
	M6	M8	M10	M12	M16	M20	M24
DLS without filling $\delta_{V,C2(DLS)}$ [mm]	- ¹⁾		5,0			4,8	4,2
ULS without filling $\delta_{V,C2(ULS)}$ [mm]	- ¹⁾		7,8	6,3	8,8	6,3	7,4
DLS with filling $\delta_{V,C2(DLS)}$ [mm]	- ¹⁾		1,2			2,0	4,2
ULS with filling $\delta_{V,C2(ULS)}$ [mm]	- ¹⁾		4,2	5,8	3,1	4,4	7,4

¹⁾ No performance assessed

fischer Bolt Anchor FAZ II Plus, FAZ II Plus R, FAZ II Plus HCR

Performances
Displacements under tension and shear loads

Annex C9