



fischer 

FIS V Plus.

The universal mortar for
all building materials.

The powerful universal mortar for concrete and masonry.



100
Years
Service life

Your advantages at a glance:

- The FIS V Plus injection mortar has numerous system approvals, such as in cracked and non-cracked concrete, masonry and for special applications.
- The ETA assessment for a service life of 100 years offers permanent safety in concrete for all applications.
- The approved use in water-filled drill holes in concrete enables a wide range of applications even under harsh environmental conditions.
- FIS VW Plus High Speed has a significantly shorter curing time than FIS V Plus, which ensures swift work progress even at low temperatures.
- The FIS VS Plus Low Speed has an extended processing time that prevents the premature hardening of the mortar at higher temperatures. It is ideally suited to large drill hole depths.
- The extensive range of accessories is ideally suited to the FIS V Plus injection mortar family, increases the great flexibility of the system and thus allows for a broad range of applications.

FIS V Plus 360 S

FIS VW Plus High Speed 360 S

FIS VS Plus Low Speed 360 S

Approvals



ETA-20/0603
EAD 330499-01-0601
for cracked concrete



ETA-20/0729, EAD
330076-00-0604
Masonry,
Use categories b,c or d



ETA-20/0728, EAD
330087-01-0601
Post-installed rebar
connections



Fire resistance
classification R 120
- Anchor types see
test report



See ICC-ES evaluation
report see at
www.icc-es.org



Seismic C1, C2

System accessories for a secure hold.

Threaded rods

- The fischer anchor rods FIS A and RG M are approved for use in concrete with FIS V Plus in sizes M6 - M30 made of galvanised and stainless steel.
- For use in masonry, the fischer anchor rods FIS A and RG M are approved in sizes M6 - M16 made of galvanised and stainless steel. In perforated brick only in combination with the anchor sleeve FIS H K in diameters 12-20.
- The variable anchoring depths allow optimum adaptation to the application and load requirement in concrete.

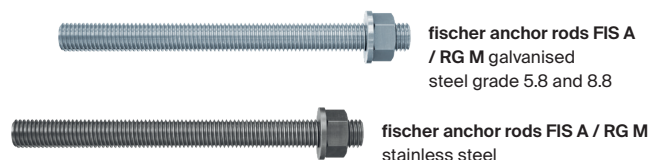

Internal threaded anchors

- The internal threaded anchor RG M I is approved for use in concrete in sizes M8 - M20 made of galvanised and stainless steel. The FIS E made of galvanised steel is approved for masonry in sizes M6 - M12.
- In combination with metric screws or threaded rods, the RG M I can be used for the installation of removable fixings.

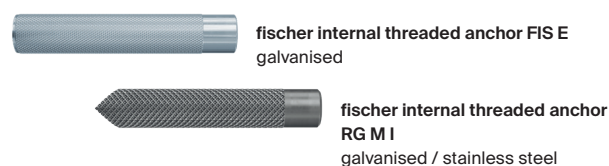

Anchor sleeves

- The grid structure of the anchor sleeve FIS H K ensures economical mortar consumption with optimum form fit.
- The centring wings ideally align the fixing element in the anchor sleeve and allow the use of different anchor rod diameters.



Shear connector

- Due to its geometry and ease of assembly, the shear connector FCC is the fast and economical alternative compared to the conventional installation with curved reinforcement bars.
- The building authority approval enables the design of the anchorage and thus offers maximum safety

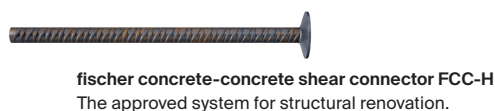

Rebar anchors

- The rebar anchor FRA is a rebar with metric connection thread made of stainless steel in sizes M12 - M24.
- With the FRA reinforcement anchor, the load-bearing capacity of the concrete is fully utilised. This allows very high tensile loads to be introduced into the anchorage base.

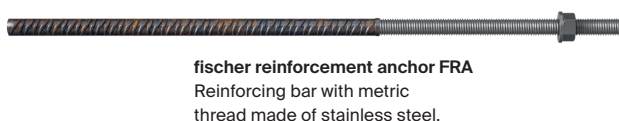



Gelling and curing times

FIS V Plus		
Temperature at anchoring base	Gelling time	Curing time
- 5 °C – ± 0 °C	-	24 hrs.
> ± 0 °C – + 5 °C	13 min.	3 hrs.
> + 5 °C – + 10 °C	9 min.	90 min.
> + 10 °C – + 20 °C	5 min.	60 min.
> + 20 °C – + 30 °C	4 min.	45 min.
> + 30 °C – + 40 °C	2 min.	35 min.

FIS VS Plus Low Speed		
Temperature at anchoring base	Gelling time	Curing time
> ± 0 °C – + 5 °C	-	6 hrs.
> + 5 °C – + 10 °C	20 min.	3 hrs.
> + 10 °C – + 20 °C	10 min.	2 hrs.
> + 20 °C – + 30 °C	6 min.	60 min.
> + 30 °C – + 40 °C	4 min.	30 min.

FIS VW Plus High Speed		
Temperature at anchoring base	Gelling time	Curing time
- 10 °C – - 5 °C	-	12 hrs.
> - 5 °C – ± 0 °C	5 min.	3 hrs.
> ± 0 °C – + 5 °C	5 min.	3 hrs.
> + 5 °C – + 10 °C	3 min.	50 min.
> + 10 °C – + 20 °C	1 min.	30 min.
> + 20 °C – + 30 °C	-	-

Further information see page 19.

Application in non-cracked and cracked concrete.

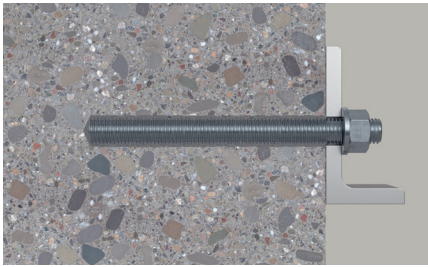

fischer anchor rod FIS A or RGM

- Diameter M6 - M30 for non-cracked concrete; diameter M8 - M30 for cracked concrete
- Made of galvanised steel in steel grades 5.8, 8.8 and stainless steel R.
- Anchorage depth 50 - 600 mm
- Load range for cracked concrete C20/25 for 3,9 - 121,2 kN

fischer internal threaded rod RG M I

- Diameter M8 - M20 in non-cracked concrete
- Available in galvanised steel and stainless steel R
- Anchorage depth 75 - 200 mm
- Load range for non-cracked concrete C20/25 for 9,0 - 65,7 kN

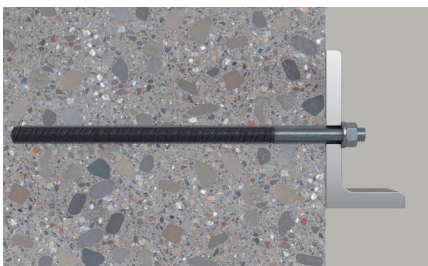

fischer rebar anchors FRA

- Reinforcing steel with stainless steel connection thread for cracked concrete
- Connection thread M12 - M20
- Anchorage depth up to 300 mm

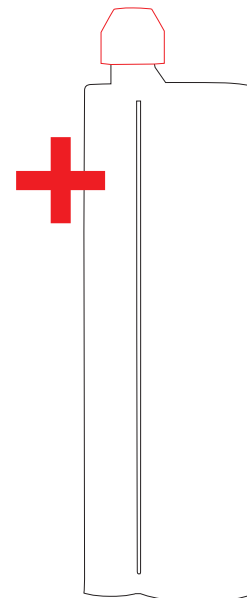

Injection mortar FIS V Plus.
Further information see page 10.

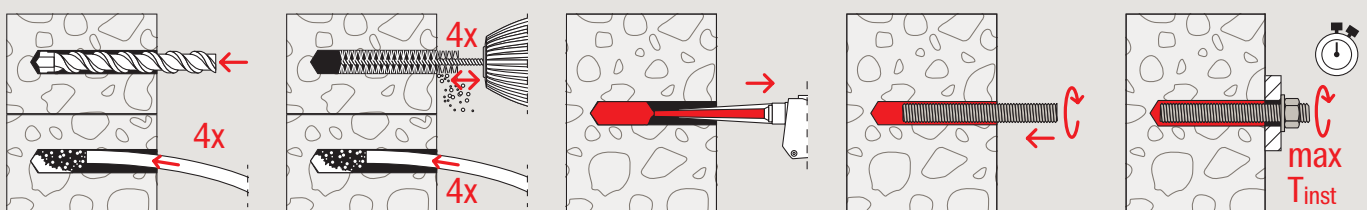

Installation in concrete with threaded rod FIS A as an example.

Application in solid masonry and aerated concrete.

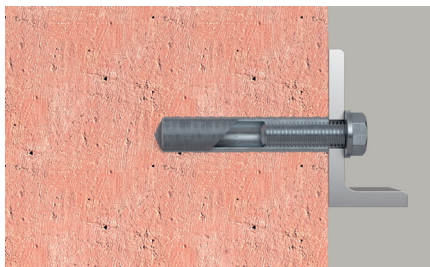
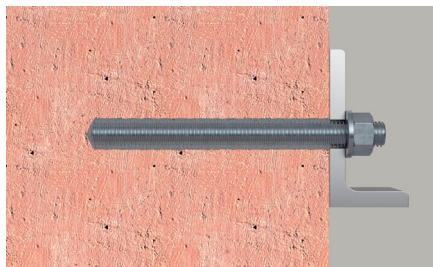

fischer anchor rod FIS A or RGM

Available as galvanised steel in steel grades 5.8, 8.8 and as stainless steel R.

Solid masonry:

- Diameter M6 - M16
- Anchorage depth 50 - 200 mm

Aerated concrete (cylindrical drill hole):

- Diameter M8 - M16
- Anchorage depth 100 mm

fischer internal threaded anchor FIS E

- Diameter M6 - M12
- Available as galvanised steel
- Anchorage depth 85 mm

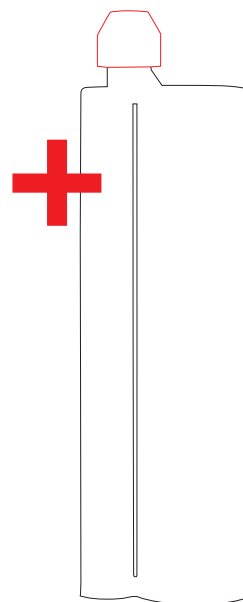

Injection mortar FIS V Plus.
Further information see page 10.

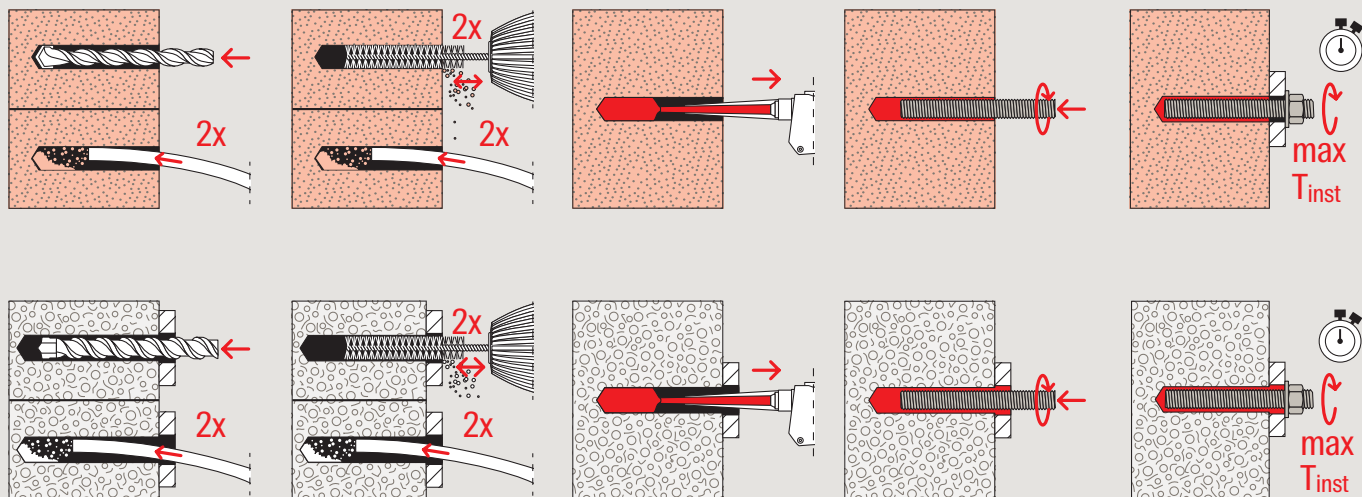

Universally applicable in perforated brick masonry.

In various perforated bricks, such as vertically perforated bricks, sand-lime bricks, hollow bricks and many more.

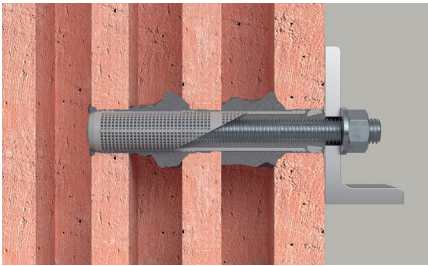

fischer anchor rod FIS A or RGM

- Diameter M6 - M16
- As galvanised steel in steel grades 5.8, 8.8 and stainless steel R available
- Anchorage depth 50, 85, 130 and 200 mm

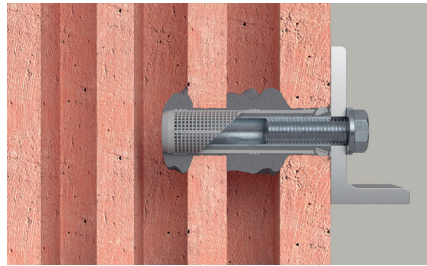

fischer internal threaded anchor FIS E

- Diameter M6 - M12
- Available as galvanised steel
- Anchorage depth 85 mm

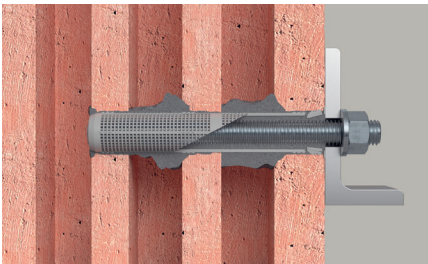

fischer anchor sleeve FIS H K

- Anchor sleeves \varnothing 12, 16 and 20 for anchor rods M6 - M16 or internal threaded anchors M6 - M12
- Anchorage depth 50, 85, 130 and 200 mm
- The grid structure ensures economical mortar consumption and an optimal form fit in the perforated brick
- The lateral centring wings align the anchor rod centrally and allow the use of different anchor rod diameters

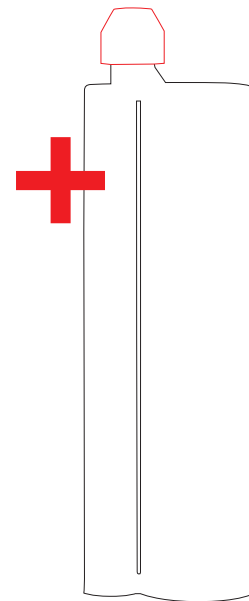

Injection mortar FIS V Plus.
Further information see page 10.

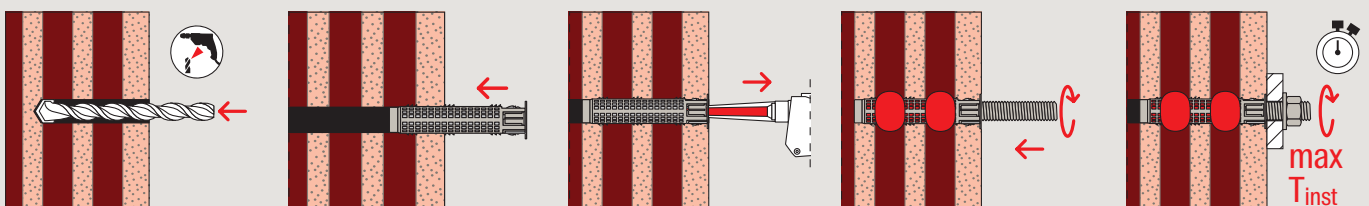

Special applications are our strength.



Post-installed rebar connections

This way, post-installed reinforcement connections are carried out professionally.

Approved system for post-installed reinforcement connections

- The injection mortar FIS V Plus can be used for post-installed rebar connections with a diameter of 8-28 mm. Furthermore, an embedment depth of up to 2.000 mm can be carried out with the FIS V Plus injection mortar.
- The reinforcement anchor FRA with stainless steel connection thread fully utilises the load-bearing capacity of the concrete. This allows very high tensile loads to be introduced into the anchoring base.
- Site-compatible accessories such as injection aids and extension hoses ensure rapid work progress. The FIS reinforcement case contains all the necessary individual components and thus ensures convenient installation.

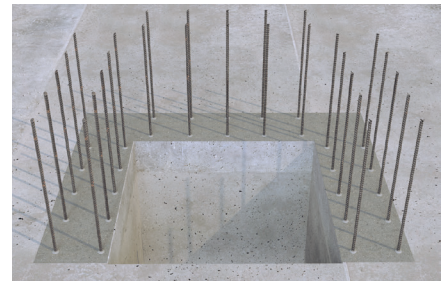

ETA-20/0728, EAD 330087-01-0601
Post-installed rebar connection.

Remedial wall tie VBS 8

How to refurbish professionally.

The professional and safe renovation of facing masonry

- Approved for the subsequent needling of double-shell masonry.
- The combination of FIS V Plus injection mortar, anchor sleeve and non-rusting wire anchor results in a very high load-bearing capacity even in problematic building materials.
- The drill diameter of only 8 mm guarantees low mortar consumption and high economic efficiency.
- No negative impact on the visual appearance due to the almost invisible fixing in the joint.



With general building authority approval.

Weather facing reconstruction system FWS II

This is how weather shells are economically secured.

Approved for the subsequent securing of three-layer exterior wall panels

- The FWS II weather facing reconstruction anchor is injected with the FIS V Plus injection mortar into the base course and the weather shell.
- The large cross-section of the bolt ensures a high transverse load-bearing capacity. I.e. cost saving due to fewer anchors per plate.
- The integrated visual inspection indicates the correct anchoring of the FWS II and thus ensures a high level of installation safety.



With general building authority approval.



Stand-off installation system TherMax 12/16

The approved stand-off installation with thermal separation in external thermal insulation composite systems.

Secure hold on insulated walls by our fixing specialists

- The stand-off installation system is suitable in combination with the FIS V Plus injection mortar for high loads in a variety of building materials. This enables secure fastening.
- The plastic cone interrupts the thermal bridge between the add-on part and the internal fastening and offers an energetically optimised fastening.
- The glass fibre-reinforced plastic cone mills into the external thermal insulation composite systems and thus enables simple, fast and adjustable installation without special tools.



With general building authority approval.



The battery dispenser for professionals.



The advantages at a glance

- The dosing function enables the efficient adjustment of the mortar quantity to match the drill hole size.
- The dispensing speed can be adjusted to the application via a controller.
- The detachable handle and belt hook ensure particularly ergonomic use.
- The sturdy design of the device guarantees reliable and long-lasting processing under demanding building site conditions.
- The 18V technology provides for the necessary dispensing power. Furthermore, the battery is compatible with all Cordless Alliance System (CAS) power tools and chargers worldwide.

More information:

www.fischer-international.com/dispenser

Product range.

FIS V Plus 300T



FIS V Plus 300 T

Item	Item No.	Approval			Languages on the cartridge	Contents	Sales unit [pcs]
		DIBt	ETA	ICC			
FIS V Plus 300 T (DE)	563281	●	●	●	DE	1 cartridge 300ml, 2x FIS MR Plus	12
FIS V Plus 300 T (IT,DE,EN)	563282	●	●	●	IT,DE,EN	1 cartridge 300ml, 2x FIS MR Plus	12
FIS V Plus 300 T (EN,ES,PT)	563292	●	●	●	EN,ES,PT	1 cartridge 300ml, 2x FIS MR Plus	12
FIS V Plus 300 T (DA,NO,SV,FI)	569074	●	●	●	DA,NO,SV,FI	1 cartridge 300ml, 2x FIS MR Plus with transparent Clip	10
FIS V Plus 300 T (EN,FR,AR)	569254	●	●	●	EN,FR,AR	1 cartridge 300ml, 2x FIS MR Plus	12
FIS VS Plus 300 T (ES,PT)	563278	●	●	●	ES,PT	1 cartridge 300ml, 2x FIS MR Plus with transparent Clip	10
FIS VS Plus 300 T (DE,FR,NL)	563279	●	●	●	DE,FR,NL	1 cartridge 300ml, 2x FIS MR Plus	12
FIS VS Plus 300 T (EN,ES,PT)	563280	●	●	●	EN,ES,PT	1 cartridge 300ml, 2x FIS MR Plus	12
FIS VS Plus 300 T (PL,HU,EL,RO)	563290	●	●	●	PL,HU,EL,RO	1 cartridge 300ml, 2x FIS MR Plus	12
FIS VS Plus 300 T (FR)	563291	●	●	●	FR	1 cartridge 300ml, 2x FIS MR Plus	12
FIS VW Plus 300 T (DA,NO,SV,FI)	563286	●	●	●	DA,NO,SV,FI	1 cartridge 300ml, 2x FIS MR Plus with transparent Clip	10
FIS VW Plus 300 T (PL,RU,HU,CS)	563287	●	●	●	PL,RU,HU,CS	1 cartridge 300ml, 2x FIS MR Plus	12
FIS VW Plus 300 T (DE,EN,IT,HU)	563293	●	●	●	DE,EN,IT,HU	1 cartridge 300ml, 2x FIS MR Plus	12

FIS V Plus 360 S



FIS V Plus 360 S

Item	Item No.	Approval			Languages on the cartridge	Contents	Sales unit [pcs]
		DIBt	ETA	ICC			
FIS V Plus 360 S (IN)	558744	●	●	●	EN	1 cartridge 360 ml, 2 x FIS MR Plus	6
FIS V Plus 360 S (DE)	558745	●	●	●	DE	1 cartridge 360 ml, 2 x FIS MR Plus	6
FIS V Plus 360 S (EN,ES,PT)	558746	●	●	●	EN, ES, PT	1 cartridge 360 ml, 2 x FIS MR Plus	6
FIS V Plus 360 S (AR,ZH,EN)	558747	●	●	●	AR, ZH, EN	1 cartridge 360 ml, 2 x FIS MR Plus	6
FIS V Plus 360 S (DE,FR,NL)	558752	●	●	●	DE, FR, NL	1 cartridge 360 ml, 2 x FIS MR Plus	6
FIS V Plus 360 S (IT,PL,RO)	558753	●	●	●	IT, PL, RO	1 cartridge 360 ml, 2 x FIS MR Plus	6
FIS V Plus 360 S (TR,EL,AR)	558754	●	●	●	TR, EL, AR	1 cartridge 360 ml, 2 x FIS MR Plus	6
FIS V Plus 360 S (DK,NO,SE,FI)	558755	●	●	●	DK, NO, SE, FI	1 cartridge 360 ml, 2 x FIS MR Plus	6
FIS V Plus 360 S (EN,ES,PT)	558758	●	●	●	EN, ES, PT	1 cartridge 360 ml, 2 x FIS MR Plus	6
FIS V Plus 360 S (RU,UK,KK)	558760	●	●	●	RU, UK, KK	1 cartridge 360 ml, 2 x FIS MR Plus	6
FIS V Plus 360 S (CS,SK,HU)	558762	●	●	●	CS, SK, HU	1 cartridge 360 ml, 2 x FIS MR Plus	6

FIS VS Plus Low Speed 360 S



FIS VS Plus Low Speed 360 S

Item	Item No.	Approval			Languages on the cartridge	Contents	Sales unit [pcs]
		DIBt	ETA	ICC			
FIS VS Plus Low Speed 360 S (ZH,JA,KO)	558749	●	●	●	ZH, JA, KO	1 cartridge 360 ml, 2 x FIS MR Plus	6
FIS VS Plus Low Speed 360 S (EN,ES,PT)	558750	●	●	●	EN, ES, PT	1 cartridge 360 ml, 2 x FIS MR Plus	6

Product range.

FIS VW Plus High Speed 360 S



FIS VW Plus High Speed 360 S

Item	Item No.	Approval			Languages on the cartridge	Contents	Sales unit [pcs]
		DIBt	ETA	ICC			
FIS VW Plus High Speed 360 S (DE)	558759	●	●	●	DE	1 cartridge 360 ml, 2 x FIS MR Plus	6
FIS VW Plus High Speed 360 S (EN,HU)	558764	●	●	●	EN, HU	1 cartridge 360 ml, 2 x FIS MR Plus	6
FIS VW Plus High Speed 360 S (DE,FR,NL)	558765	●	●	●	DE, FR, NL	1 cartridge 360 ml, 2 x FIS MR Plus	6
FIS VW Plus High Speed 360 S (RU,UK,KK)	558767	●	●	●	RU, UK, KK	1 cartridge 360 ml, 2 x FIS MR Plus	6
FIS VW Plus High Speed 360 S (PL,CS,RO)	558768	●	●	●	PL, CS, RO	1 cartridge 360 ml, 2 x FIS MR Plus	6
FIS VW Plus High Speed 360 S (DA,NO,SV,FI)	569072	●	●	●	DA, NO, SV, FI	1 cartridge 360 ml, 2 x FIS MR Plus	6

FIS V Plus 360 S HWK K



FIS V Plus 360 S HWK K

Item	Item No.	Approval			Languages on the cartridge	Contents	Sales unit [pcs]
		DIBt	ETA	ICC			
FIS VS Plus 300 T (DE,FR,NL) HWK K	563283	●	●	●	DE,FR,NL	10 cartridges 300ml, 20 static mixer FIS MR Plus	1
FIS V Plus 360 S (DE) HWK K	558770	●	●	●	DE	10 cartridges 360 ml, 20 static mixer FIS MR Plus	1
FIS V Plus 360 S (CS,SK,HU) HWK K	558771	●	●	●	CS, SK, HU	10 cartridges 360 ml, 20 static mixer FIS MR Plus	1
FIS V Plus 360 S (DE,FR,NL) HWK K	558769	●	●	●	DE, FR, NL	10 cartridges 360 ml, 20 static mixer FIS MR Plus	1

FIS V Plus 360 S HWK G



FIS V Plus 360 S HWK G

Item	Item No.	Approval			Languages on the cartridge	Contents	Sales unit [pcs]
		DIBt	ETA	ICC			
FIS VS Plus 300 T (DE,FR,NL) HWK G	563294	●	●	●	DE,FR,NL	20 cartridges 300ml, 40 static mixer FIS MR Plus	1
FIS V Plus 360 S (DE) HWK G	558756	●	●	●	DE	20 cartridges 360 ml, 40 static mixer FIS MR Plus	1
FIS V Plus 360 S (AR,ZH,EN) HWK G	558748	●	●	●	AR, ZH, EN	20 cartridges 360 ml, 40 static mixer FIS MR Plus	1
FIS V Plus 360 S (DE,FR,NL) HWK G	558757	●	●	●	DE, FR, NL	20 cartridges 360 ml, 40 static mixer FIS MR Plus	1

FIS VW Plus High Speed 360 S HWK G



FIS VW Plus High Speed 360 S HWK G

Item	Item No.	Approval			Languages on the cartridge	Contents	Sales unit [pcs]
		DIBt	ETA	ICC			
FIS VW Plus High Speed 360 S (DE) HWK G	558766	●	●	●	DE	20 cartridges 360 ml, 40 static mixer FIS MR Plus	1

FIS V Plus 360 S BT



FIS V Plus 360 S BT

Item	Item No.	Approval			Languages on the cartridge	Contents	Sales unit [pcs]
		DIBt	ETA	ICC			
FIS V Plus 300 T AUS (EN,FR,AR) BT	563288	●	●	●	EN,FR,AR	20 cartridges 300ml, 40x FIS MR Plus	1
FIS VS Plus 300 T (PL,HU,EL,RO) BT	563296	●	●	●	PL,HU,EL,RO	20 cartridges 300ml, 40x FIS MR Plus	1
FIS V Plus 360 S (DE,FR,NL) BT	558763	●	●	●	DE, FR, NL	20 cartridges 360 ml, 20 static mixer FIS MR Plus	1
FIS V Plus 360 S (EN) BT	558743	●	●	●	EN	20 cartridges 360 ml, 40 static mixer FIS MR Plus	1
FIS V Plus 360 S (AR,ZH,EN) BT	558751	●	●	●	AR, ZH, EN	20 cartridges 360 ml, 20 static mixer FIS MR Plus	1
FIS V Plus 360 S (RU,UK,KK) BT	558772	●	●	●	RU, UK, KK	20 cartridges 360 ml, 40 static mixer FIS MR Plus	1

FIS V Plus 360 S HWK G + FIS DM S



FIS V Plus 360 S HWK G + FIS DMS Pro

Item	Item No.	Approval			Languages on the cartridge	Contents	Sales unit [pcs]
		DIBt	ETA	ICC			
FIS V Plus 360 S (DK,NO,SE,FI) HWK G + FIS DM S	558775	●	●	●	DK, NO, SE, FI	12 cartridges 360 ml, 24 x FIS MR Plus, 1 x dispenser FIS DM S Pro	1
FIS V Plus 360 S (DE,FR,NL) HWK G + FIS DM S	560032	●	●	●	DE, FR, NL	12 cartridges 360 ml, 24 x FIS MR Plus, 1 x dispenser FIS DM S Pro	1
FIS V Plus 360 S (IT,PL,RO) HWK G + FIS DM S	558773	●	●	●	IT, PL, RO	12 cartridges 360 ml, 24 x FIS MR Plus, 1 x dispenser FIS DM S Pro	1
FIS V Plus 360 S (CS,SK,HU) HWK G + FIS DM S	560033	●	●	●	CS, SK, HU	12 cartridges 360 ml, 24 x FIS MR Plus, 1 x dispenser FIS DM S Pro	1

FIS V Plus 410 C



FIS V Plus 410 C

Item	Item No.	Approval			Languages on the cartridge	Contents	Sales unit [pcs]
		DIBt	ETA	ICC			
FIS V Plus 410 C (EN,ES,PT)	558784	●	●	●	EN, ES, PT	1 cartridge 410 ml, 2 x FIS MR Plus	12
FIS V Plus 410 C (IT,DE,EN)	558780	●	●	●	IT, DE, EN	1 cartridge 410 ml, 2 x FIS MR Plus	12
FIS VW Plus 410 (DE, FR, IT)	569342	●	●	●	DE, FR, IT	1 cartridge 410ml, 2x FIS MR Plus	12
FIS VW Plus High Speed 380 C (PL,CS,SK)	558785	●	●	●	PL, CS, SK	1 cartridge 380 ml, 2 x FIS MR Plus	12
FIS V Plus 410 C (IT,DE,EN) HWK G	558781	●	●	●	IT, DE, EN	16 cartridges 410 ml, 32 x FIS MR Plus	1
FIS V Plus 410 C (RU,EN,TR) BT	558783	●	●	●	RU, EN, TR	16 cartridges 410 ml, 32 x FIS MR Plus	1
FIS V Plus 410 C (IT,DE,EN) BT	558782	●	●	●	IT, DE, EN	16 cartridges 410 ml, 32 x FIS MR Plus	1

FIS V Plus 825 S



FIS V Plus 825 S

Item	Item No.	Approval			Languages on the cartridge	Contents	Sales unit [pcs]
		DIBt	ETA	ICC			
FIS V Plus 825 S (DE,EN,FR,IT,NL)	567511	●	●	●	DE,EN,FR,IT,NL	1 cartridge 825 ml, 2 x FIS JMR	6
FIS V Plus 825 S (EN,ES,PT,FR,TR)	567512	●	●	●	EN,ES,PT,FR,TR	1 cartridge 825 ml, 2 x FIS JMR	6
FIS V Plus 825 S (EN,PL,RU,CZ,SK)	567513	●	●	●	EN,PL,RU,CZ,SK	1 cartridge 825 ml, 2 x FIS JMR	6

Accessories.

Static mixer



FIS MR Plus

FIS JMR

Item	Item No.	Contents	Sales unit [pcs]
FIS MR Plus	545853	10 static mixer	10
FIS JMR	567522	12 static mixer	12

Dispenser



FIS DM S Pro



FIS AM



FIS AM S-XL



FIS DB S Pro



FIS DB SL Pro



FIS AP

Artikelbezeichnung	Art.-Nr.	Inhalt	Geeignet für	Sales unit [Stück]
FIS DM S Pro	563337	Manual dispenser	150 T, 300 T, 360 S, 390 S cartridges	1
FIS AM	058000	Manual dispenser	150 T, 300 T, 360 S, 390 S cartridges	1
FIS AM S-XL	563241	Manual dispenser	525 S cartridges	1
FIS DB S Pro (EU)	558955	Akku-Auspressgerät mit 1x Ladegerät 12-36V EU, 1x Akku 18V 2,0 Ah, 1x abnehmbarem Handgriff, 1x Gürtelhaken, 1x Hartschalenkoffer	150 T, 300 T, 360 S, 390 S cartridges	1
FIS DB S Pro (UK)	564960	Battery operated dispenser with 1x charger 12-36V UK, 1x battery pack 18V 2.0Ah, 1x screw off handle, 1x belt hook, 1x hard case	150 T, 300 T, 360 S, 390 S cartridges	1
FIS DB S Pro Solo	567189	Battery operated dispenser with 1x screw off handle, 1x belt hook, 1x hard case	150 T, 300 T, 360 S, 390 S cartridges	1
FIS DB SL Pro (EU)	562004	Battery operated dispenser with 1x charger 12-36V EU, 1x battery pack 18V 2.0Ah, 1x screw off handle, 1x belt hook, 1x hard case	585 S, 825 S cartridges	1
FIS DB SL Pro (UK)	564961	Battery operated dispenser with 1x charger 12-36V UK, 1x battery pack 18V 2.0Ah, 1x screw off handle, 1x belt hook, 1x hard case	585 S, 825 S cartridges	1
FIS DB SL Pro Solo	567295	Battery operated dispenser with 1x screw off handle, 1x belt hook, 1x hard case	585 S, 825 S cartridges	1
FSS-B 18V 2,0Ah	563787	Battery Pack	FIS DB S Pro, FIS DB SL Pro	1
FSS-B 18V 4,0Ah	552930	Battery Pack	FIS DB S Pro, FIS DB SL Pro	1
FIS AP	058027	Pneumatic dispenser	150 T, 300 T, 360 S, 390 S cartridges	1

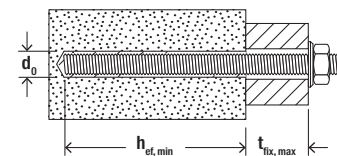

Anchor rod FIS A: Application in solid masonry, perforated brick masonry and aerated concrete



FIS A

Item	Zinc-plated, steel grade 5.8 Art.-No. gvz.	Stainless steel R Art.-No. R	Approval ETA	Application in solid masonry				Application in perforated brick masonry	Application in aerated concrete			Sales unit [pcs]
				Drill hole diameter d_0 [mm]	Min. anchorage depth $h_{et,min}$ [mm]	Max. usable length $t_{fix,max}$ [mm]	Min. filling quantity [scale units]	Appropriate anchor sleeves	Drill hole diameter d_0 [mm]	Min. anchorage depth $h_{et,min}$ [mm]	Min. filling quantity [scale units]	
FIS A M 6 x 70	046204	046205	●	8	50	11	2	FIS H 12 x 50 K	-	-	-	10
FIS A M 6 x 75	090243	090437	●	8	50	17	2	FIS H 12 x 50 K	-	-	-	20
FIS A M 6 x 85	090272	090438	●	8	50	27	2	FIS H 12 x 50 K	-	-	-	20
FIS A M 6 x 110	090273	090439	●	8	50	50	2	FIS H 12 x 50 K, FIS H 12 x 85 K	-	-	-	20
FIS A M 8 x 70	046206	046245	●	10	50	9	2	FIS H 12 x 50 K	-	-	-	10
FIS A M 8 x 90	090274	090440	●	10	50	29	2	FIS H 12 x 50 K	10	100	3	10
FIS A M 8 x 110	090275	090441	●	10	50	49	2	FIS H 12 x 50 K, FIS H 12 x 85 K, FIS H 16 x 85 K	10	100	3	10
FIS A M 8 x 130	090276	090442	●	10	50	69	2	FIS H 12 x 50 K, FIS H 12 x 85 K, FIS H 16 x 85 K	10	100	3	10
FIS A M 8 x 175	090277	090443	●	10	50	114	2	FIS H 12 x 50 K, FIS H 12 x 85 K, FIS H 16 x 85 K, FIS H 16 x 130 K	10	100	3	10
FIS A M 10 x 110	090278	090444	●	12	50	30	3	FIS H 16 x 85 K	12	100	4	10
FIS A M 10 x 130	090279	090447	●	12	50	50	3	FIS H 16 x 85 K	12	100	4	10
FIS A M 10 x 150	090281	090448	●	12	50	70	3	FIS H 16 x 85 K, FIS H 16 x 130 K	12	100	4	10
FIS A M 10 x 170	044969	044973	●	12	50	90	3	FIS H 16 x 85 K, FIS H 16 x 130 K	12	100	4	10
FIS A M 10 x 200	090282	090449	●	12	50	120	3	FIS H 16 x 85 K, FIS H 16 x 130 K	12	100	4	10
FIS A M 12 x 120	044971	044974	●	14	50	39	4	FIS H 20 x 85 K	14	100	4	10
FIS A M 12 x 140	090283	090450	●	14	50	59	4	FIS H 20 x 85 K	14	100	5	10
FIS A M 12 x 160	090284	090451	●	14	50	79	4	FIS H 20 x 85 K, FIS H 20 x 130 K	14	100	5	10
FIS A M 12 x 180	090285	090452	●	14	50	99	4	FIS H 20 x 85 K, FIS H 20 x 130 K	14	100	5	10
FIS A M 12 x 210	090286	090453	●	14	50	129	4	FIS H 20 x 85 K, FIS H 20 x 130 K	14	100	5	5
FIS A M 12 x 260	090287	090454	●	14	50	179	4	FIS H 20 x 85 K, FIS H 20 x 130 K, FIS H 20 x 200 K	14	100	5	5
FIS A M 16 x 130	044972	044975	●	18	50	20	8	FIS H 20 x 85 K	18	100	6	10
FIS A M 16 x 175	090288	090455	●	18	50	65	8	FIS H 20 x 85 K, FIS H 20 x 130 K	18	100	6	10
FIS A M 16 x 200	090289	090456	●	18	50	90	8	FIS H 20 x 85 K, FIS H 20 x 130 K	18	100	6	10
FIS A M 16 x 250	090290	090457	●	18	50	140	8	FIS H 20 x 85 K, FIS H 20 x 130 K, FIS H 20 x 200 K	18	100	6	10
FIS A M 16 x 300	090291	090458	●	18	50	190	8	FIS H 20 x 85 K, FIS H 20 x 130 K, FIS H 20 x 200 K	18	100	6	10

Accessories.

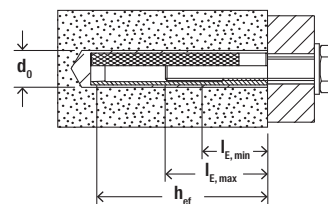

Internal threaded anchor FIS E: Application in solid masonry, perforated brick masonry and aerated concrete



FIS E

Item	Zinc-plated steel	Technical data				Application in solid masonry		Application in perforated brick masonry	Application in aerated concrete			Sales unit
		Approval	Effect. anchorage depth	Min. bolt penetration	Max. bolt penetration	Drill hole diameter	Fill quantity for min. anchorage depth	Appropriate anchor sleeves	Drill hole diameter	Min. anchorage depth	Fill quantity for min. anchorage depth	
	Art.-No. gvz.	ETA	h_{ef} [mm]	$l_{E,min}$ [mm]	$l_{E,max}$ [mm]	d_0 [mm]	[scale units]		d_0 [mm]	$h_{ef,min}$ [mm]	[scale units]	[pcs]
FIS E 11 x 85 M6	043631	●	85	6	60	14	4	FIS H 16 x 85 K, FIS H 20 x 85 K	14	85	4	10
FIS E 11 x 85 M8	043632	●	85	8	60	14	4	FIS H 16 x 85 K, FIS H 20 x 85 K	14	85	4	10
FIS E 15 x 85 M10	043633	●	85	10	60	18	5	FIS H 20 x 85 K	18	85	5	10
FIS E 15 x 85 M12	043634	●	85	12	60	18	5	FIS H 20 x 85 K	18	85	5	10

Injection anchor sleeve FIS H K for perforated brick masonry



FIS H K

FIS HK

FIS Set 18 x 130/200 M12/200

Item	Art.-No.	Approval	Drill hole diameter	Min. drill hole depth	Min. anchorage depth	Max. usable length	Suitable for	Fill quantity per sleeve	Sales unit
FIS H 12 x 50 K	041900	●	12	60	50	–	FIS A M6 – M8	5	50
FIS H 12 x 85 K	041901	●	12	95	85	–	FIS A M6 – M8	10	50
FIS H 16 x 85 K	041902	●	16	95	85	–	FIS A M8 – M10, FIS E M6 – M8	12	50
FIS H 16 x 130 K	041903	●	16	140	130	–	FIS A M8 – M10	15	20
FIS H 20 x 85 K	041904	●	20	95	85	–	FIS A M12 – M16, FIS E M10 – M12	15	20
FIS H 20 x 130 K	046703	●	20	140	130	–	FIS A M12 – M16	25	20
FIS H 20 x 200 K	046704	●	20	210	200	–	FIS A M12 – M16	40	20
FIS H 18 x 130/200 K	045707	●	18	340	130	200	M10 – M12	35	10
FIS H 22 x 130/200 K	045708	●	22	340	130	200	M 16	45	10
FIS Set 18 x 130/200 M12/200 R ¹⁾	047452	●	18	340	130	200	M12 R in Set	35	5
FIS Set 18 x 130/200 M12/200 ¹⁾	047443	●	18	340	130	200	M12 in Set	35	5

¹⁾ With anchor rod.

Injection anchor sleeve, 1 m length FIS H L for perforated brick masonry



FIS H L

Item	Art.-No.	Drill hole diameter d_0 [mm]	Total length l [mm]	Suitable for	Fill quantity per 10 cm [scale units]	Sales unit [pcs]
FIS H 12 x 1000 L	050598	12	1.000	Ø6/M 6-Ø8/M 8	12	10
FIS H 16 x 1000 L	050599	16	1.000	Ø10/M10, Ø12/M12	14	10
FIS H 22 x 1000 L	045301	22	1.000	Ø12/M12 - Ø16/M16	20	6
FIS H 30 x 1000 L	000645	30	1.000	Ø16/M16 - Ø22/M22	26	4

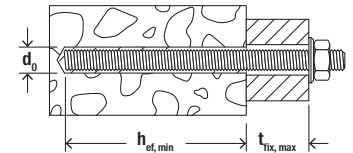

Anchor rod FIS A: Application in concrete

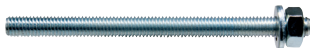

FIS A

Item	Zinc plated, steel grade 5.8 Art.-No. gvz 5.8	Zinc plated, steel grade 8.8 Art.-No. gvz 8.8	Stainless steel R 70 Art.-No. R 70	Approval ETA	Drill hole diameter d_0 [mm]	Min. effective anchorage depth $h_{ef,min}$ [mm]	Max. effective length at $h_{ef,min}$ $t_{fix, h_{ef,min}}$ [mm]	Fill quantity for FIS V Plus at $h_{ef,min}$ [scale units]	Max. anchoring depth $h_{ef,max}$ [mm]	Max. usable length at $h_{ef,max}$ $t_{fix, h_{ef,max}}$ [mm]	Fill quantity for FIS V Plus at $h_{ef,max}$ [scale units]	Sales unit [pcs]
FIS A M 6 x 85 ²⁾	090272	-	090438	●	8	50	26	2	72	4	3	10
FIS A M 6 x 110 ²⁾	090273	-	090439	●	8	50	51	2	72	29	3	10
FIS A M 8 x 90	090274	519390	090440	●	10	60	19	2	78	1	3	10
FIS A M 8 x 110	090275	519391	090441	●	10	60	39	2	98	1	3	10
FIS A M 8 x 130	090276	519392	090442	●	10	60	59	2	118	1	4	10
FIS A M 8 x 175	090277	519393	090443	●	10	60	104	2	160	4	5	10
FIS A M 8 x 1000	509214	519394	509230	●	10	60	-	2	160	-	5	10
FIS A M 10 x 110	090278	-	090444	●	12	60	37	3	96	1	4	10
FIS A M 10 x 130	090279	-	090447	●	12	60	57	3	116	1	5	10
FIS A M 10 x 150	090281	517935	090448	●	12	60	77	3	136	1	5	10
FIS A M 10 x 170	044969	519395	044973	●	12	60	97	3	156	1	6	10
FIS A M 10 x 190	-	517936	519420	●	12	60	117	3	176	1	7	10
FIS A M 10 x 200	090282	519396	090449	●	12	60	127	3	186	1	7	10
FIS A M 10 x 1000 ¹⁾	509215	509223	509231	●	12	60	-	3	200	-	7	10
FIS A M 12 x 120	044971	519397	044974	●	14	70	34	3	103	1	5	10
FIS A M 12 x 140	090283	519398	090450	●	14	70	54	3	123	1	6	10
FIS A M 12 x 160	090284	517937	090451	●	14	70	74	3	143	1	7	10
FIS A M 12 x 180	090285	519399	090452	●	14	70	94	3	163	1	7	10
FIS A M 12 x 200	-	517938	519421	●	14	70	114	3	183	1	8	10
FIS A M 12 x 210	090286	-	090453	●	14	70	124	3	193	1	9	10
FIS A M 12 x 260	090287	-	090454	●	14	70	174	3	240	4	10	10
FIS A M 12 x 1000 ¹⁾	509216	509224	509232	●	14	70	-	3	240	-	10	10
FIS A M 16 x 130	044972	519400	044975	●	18	80	30	5	109	1	7	10
FIS A M 16 x 175	090288	519401	090455	●	18	80	75	5	154	1	10	10
FIS A M 16 x 200	090289	517939	090456	●	18	80	100	5	179	1	11	10
FIS A M 16 x 250	090290	517940	090457	●	18	80	150	5	229	1	14	10
FIS A M 16 x 300	090291	519402	090458	●	18	80	200	5	279	1	17	10
FIS A M 16 x 1000 ¹⁾	509217	509225	509233	●	18	80	-	5	320	-	19	10

1) Without nut and washer - FIS A high corrosion resistant steel 1.4529 on request. Other sizes on request.

2) Option 7 assessment

Accessories.

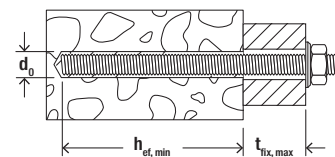

Anchor rod FIS A: Application in concrete



FIS A

Item	Zinc plated, steel grade 5.8	Zinc plated, steel grade 8.8	Stainless steel R 70	Approval	Drill hole diameter	Min. effective anchorage depth	Max. effective length at $h_{ef, min}$	Fill quantity for FIS V Plus at $h_{ef, min}$	Max. anchoring depth	Max. usable length at $h_{ef, max}$	Fill quantity for FIS V Plus at $h_{ef, max}$	Sales unit
	Art.-No. gvz 5.8	Art.-No. gvz 8.8	Art.-No. R 70	ETA	d_0 [mm]	$h_{ef, min}$ [mm]	$t_{fix}, h_{ef, min}$ [mm]	[scale units]	$h_{ef, max}$ [mm]	$t_{fix}, h_{ef, max}$ [mm]	[scale units]	[pcs]
FIS A M 20 x 245	090292	519404	090459	●	24	90	131	11	220	1	28	10
FIS A M 20 x 290	090293	519406	090460	●	24	90	176	11	265	1	32	10
FIS A M 20 x 1000 ¹⁾	-	519410	519427	●	24	90	-	11	400	-	48	10
FIS A M 24 x 290	090294	-	090468	●	28	96	165	15	260	1	39	5
FIS A M 24 x 380	090295	-	090462	●	28	96	255	15	350	1	52	5
FIS A M 30 x 340	090296	-	090463	●	35	120	185	28	304	1	67	5
FIS A M 30 x 430	090297	-	090464	●	35	120	275	28	394	1	88	5

1) Without nut and washer - FIS A high corrosion resistant steel 1.4529 on request. Other sizes on request.

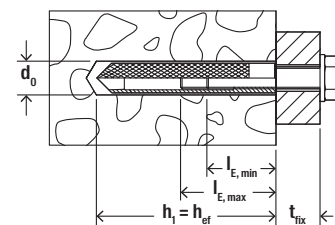

Internal threaded anchor RG M I in concrete



RG M I

Item	Zinc plated, steel grade 5.8	Stainless steel R 70	Approval	Drill hole diameter	Min. bolt penetration	Max. bolt penetration	Fill quantity	Sales unit
	Art.-No. gvz 5.8	Art.-No. R 70	ETA	d_0 [mm]	$l_{E, min}$ [mm]	$l_{E, max}$ [mm]	[scale units]	[pcs]
RG 8 x 75 M 5 I	048221 ¹⁾	-	-	10	8	14	5	10
RG 10 x 75 M 6 I	048222 ¹⁾	-	-	12	10	16	5	10
RG 12 x 90 M 8 I	050552 ¹⁾	050565 ¹⁾	●	14	12	18	5	10
RG 16 x 90 M 10 I	050553 ¹⁾	050566 ¹⁾	●	18	15	23	7	10
RG 18 x 125 M 12 I	050562 ¹⁾	050567 ¹⁾	●	20	18	26	11	10
RG 22 x 160 M 16 I	050563 ¹⁾	050568 ¹⁾	●	24	24	35	17	5
RG 28 x 200 M 20 I	050564 ¹⁾	050569 ¹⁾	●	32	30	45	48	5

1) Setting tool is included in each package.

Hexagonal nut and washer



Nut

Washer

Item	Zinc-plated steel	Stainless steel R	Width across nut SW	Washer (outer diameter x thickness)	Suitable for	Sales unit [pcs]
	Art.-No.	Art.-No.	[mm]	[mm]		
Nut & washer M8	510509	510113	13	16 x 1,6	FIS A M8 x 1.000	50
Nut & washer M10	510510	510514	17	20 x 2	FIS A M10 x 1.000	50
Nut & washer M12	510511	510515	19	24 x 2,5	FIS A M12 x 1.000	25
Nut & washer M16	510512	510516	24	30 x 3	FIS A M16 x 1.000	20
Nut & washer M20	519737	513738	30	37 x 3	FIS A M20 x 1.000	10

Accessories drill hole cleaning

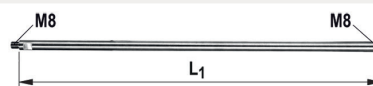
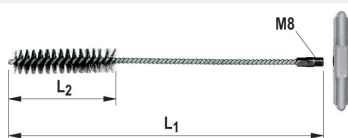

Cleaning brush BS

SDS-Adapter M8

Brush extension

Item	Art.-No.	Length L ₁	Length L ₂	Brush diameter	For drill diameter	Sales unit
		[mm]	[mm]	[mm]	[mm]	[pcs]
BS ø 8	078177	120	50	9	8	1
BS ø 10	078178	120	50	11	10	1
BS ø 12	078179	150	80	13	12	1
BS ø 14	078180	250	80	16	14	1
BS ø 16/18	078181	250	80	20	16/18	1
BS ø 20	052277	180	80	25	20/22	1
BS ø 24	078182	300	100	26	24	1
BS ø 25	097806	300	100	27	25	1
BS ø 28	078183	350	100	30	28	1
BS ø 35	078184	400	100	40	30/32/35	1
FIS-brush extension	508791	410	—	—	—	1
Compressed air nozzle Ø 9 (1,0 m)	048983	—	—	—	—	10
Compressed air nozzle Ø 15 (10,0 m)	530800	—	—	—	—	1
SDS-Adapter M8	530332	—	—	—	—	1

Accessories drill hole cleaning air

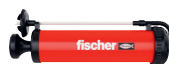

Compressed-air cleaning tool ABP

Blow-out pump AB G

Centring wedge

Item	Art.-No.	Contents	Total length [mm]	Sales unit [pcs]
Compressed-air cleaning tool ABP	059456	—	460	1
Blow-out pump AB G	567792	—	370	1
Centring wedge	093076	10 wedges for overhead installation, from M16	—	10

Loads

Injection system FIS V Plus with anchor rod FIS A resp. RG M

Permissible loads of a single anchor¹⁾²⁾ in normal concrete of strength class C20/25.
For the design the complete current assessment ETA-20/0603 has to be considered.

Type	Material / surface ³⁾	Effective anchorage depth h_{ef} [mm]	Minimum member thickness h_{min} [mm]	Maximum installation torque $T_{inst,max}$ [Nm]	Cracked concrete				Non-cracked concrete			
					Permissible tension (N_{perm}) and shear loads (V_{perm}); minimum spacing (s_{min}) and edge distances (c_{min}) with reduced loads				Permissible tension (N_{perm}) and shear loads (V_{perm}); minimum spacing (s_{min}) and edge distances (c_{min}) with reduced loads			
					N_{perm} ⁴⁾ [kN]	V_{perm} ⁴⁾ [kN]	s_{min} ⁴⁾ [mm]	c_{min} ⁴⁾ [mm]	N_{perm} ⁴⁾ [kN]	V_{perm} ⁴⁾ [kN]	s_{min} ⁴⁾ [mm]	c_{min} ⁴⁾ [mm]
FIS A M 8	5.8	60	100	10	3.9	6.3	40	40	9.0	6.3	40	40
	5.8	80	110	10	5.3	6.3	40	40	9.0	6.3	40	40
	5.8	160	190	10	9.0	6.3	40	40	9.0	6.3	40	40
	R-70	60	100	10	3.9	6.0	40	40	9.9	6.0	40	40
	R-70	80	110	10	5.3	6.0	40	40	9.9	6.0	40	40
	R-70	160	190	10	9.9	6.0	40	40	9.9	6.0	40	40
FIS A M 10	5.8	60	100	20	5.4	9.7	45	45	10.9	9.7	45	45
	5.8	90	120	20	8.1	9.7	45	45	13.8	9.7	45	45
	5.8	200	230	20	13.8	9.7	45	45	13.8	9.7	45	45
	R-70	60	100	20	5.4	9.2	45	45	10.9	9.2	45	45
	R-70	90	120	20	8.1	9.2	45	45	15.7	9.2	45	45
	R-70	200	230	20	15.7	9.2	45	45	15.7	9.2	45	45
FIS A M 12	5.8	70	100	40	8.2	14.3	55	45	13.7	14.3	55	45
	5.8	110	140	40	12.8	14.3	55	45	20.5	14.3	55	45
	5.8	240	270	40	20.5	14.3	55	45	20.5	14.3	55	45
	R-70	70	100	40	8.2	13.7	55	45	13.7	13.7	55	45
	R-70	110	140	40	12.8	13.7	55	45	22.5	13.7	55	45
	R-70	240	270	40	22.5	13.7	55	45	22.5	13.7	55	45
FIS A M 16	5.8	80	120	60	11.5	23.0	65	50	16.8	26.9	65	50
	5.8	125	170	60	18.0	26.9	65	50	32.7	26.9	65	50
	5.8	320	360	60	37.6	26.9	65	50	37.6	26.9	65	50
	R-70	80	120	60	11.5	23.0	65	50	16.8	25.2	65	50
	R-70	125	170	60	18.0	25.2	65	50	32.7	25.2	65	50
	R-70	320	360	60	42.0	25.2	65	50	42.0	25.2	65	50
FIS A M 20	5.8	90	140	120	14.0	28.0	85	55	20.0	40.0	85	55
	5.8	170	220	120	28.0	42.3	85	55	51.9	42.3	85	55
	5.8	400	450	120	58.6	42.3	85	55	58.6	42.3	85	55
	R-70	90	140	120	14.0	28.0	85	55	20.0	39.4	85	55
	R-70	170	220	120	28.0	39.4	85	55	51.9	39.4	85	55
	R-70	400	450	120	65.7	39.4	85	55	65.7	39.4	85	55
FIS A M 24	5.8	96	160	150	15.4	30.8	105	60	22.0	44.1	105	60
	5.8	210	270	150	37.7	60.6	105	60	71.3	60.6	105	60
	5.8	480	540	150	84.3	60.6	105	60	84.3	60.6	105	60
	R-70	96	160	150	15.4	30.8	105	60	22.0	44.1	105	60
	R-70	210	270	150	37.7	56.8	105	60	71.3	56.8	105	60
	R-70	480	540	150	86.2	56.8	105	60	94.3	56.8	105	60
FIS A M 30	5.8	120	190	300	21.6	43.1	140	80	30.8	61.6	140	80
	5.8	280	350	300	56.5	96.0	140	80	109.8	96.0	140	80
	5.8	600	670	300	121.2	96.0	140	80	133.8	96.0	140	80
	R-70	120	190	300	21.6	43.1	140	80	30.8	61.6	140	80
	R-70	280	350	300	56.5	90.2	140	80	109.8	90.2	140	80
	R-70	600	670	300	121.2	90.2	140	80	150.1	90.2	140	80

¹⁾ Design according to EN 1992-4:2018 (for static resp. quasi-static loads). The partial safety factors for material resistance as regulated in the ETA as well as a partial safety factor for load actions of $\gamma_L = 1.4$ are considered. As a single anchor counts e.g. an anchor with a spacing $s \geq 3 \times h_{ef}$ and an edge distance $c \geq 1.5 \times h_{ef}$. Accurate data see ETA.

²⁾ The specified loads are valid for anchorages in dry and damp concrete. For temperatures in the anchoring substrate up to 50 °C (resp. short term up to 80 °C). Drill hole cleaning as per specification in the ETA. The factor Ψ_{sus} for sustained load was taken into account with 1.0.

³⁾ Further steel grades, versions and technical data see ETA, e.g. for dry internal conditions, galvanised steel (gvz); for damp interiors and for outdoor use, stainless steel (R).

⁴⁾ In the case of combinations of tensile and shear loads, bending moments with reduced or minimum spacing and edge distances (anchor groups), the design must be carried out in accordance with the provisions of the complete ETA and the provisions of the EN 1992-4:2018. We recommend using our anchor design software C-FIX.

Injection system FIS V Plus with internal threaded anchor RG M I

Permissible loads of a single anchor¹⁾²⁾ in normal concrete of strength class C20/25.
For the design the complete current assessment ETA-20/0603 has to be considered.

Type	Screw Material ³⁾	Effective anchorage depth h_{ef} [mm]	Minimum member thickness h_{min} [mm]	Maximum installation torque $T_{inst, max}$ [Nm]	Non-cracked concrete			
					Permissible tension (N_{perm}) and shear loads (V_{perm}); minimum spacing (s_{min}) and edge distances (c_{min}) with reduced loads			
					N_{perm} ⁴⁾ [kN]	V_{perm} ⁴⁾ [kN]	s_{min} ⁴⁾ [mm]	c_{min} ⁴⁾ [mm]
RG M 8 I	5.8	90	120	10	9.0	5.3	55	55
	8.8	90	120	10	13.8	8.3	55	55
	R-70	90	120	10	9.9	5.9	55	55
RG M 10 I	5.8	90	130	20	13.8	8.3	65	65
	8.8	90	130	20	20.0	13.3	65	65
	R-70	90	130	20	15.7	9.3	65	65
RG M 12 I	5.8	125	170	40	20.5	12.1	75	75
	8.8	125	170	40	32.0	19.3	75	75
	R-70	125	170	40	22.5	13.5	75	75
RG M 16 I	5.8	160	210	80	37.6	22.4	95	95
	8.8	160	210	80	47.4	30.9	95	95
	R-70	160	210	80	42.0	25.1	95	95
RG M 20 I	5.8	200	260	120	58.6	35.4	125	125
	8.8	200	260	120	66.3	51.4	125	125
	R-70	200	260	120	65.7	39.4	125	125

¹⁾ Design according to EN 1992-4:2018 (for static resp. quasi-static loads). The partial safety factors for material resistance as regulated in the ETA as well as a partial safety factor for load actions of $\gamma_L = 1.4$ are considered. As a single anchor counts e.g. an anchor with a spacing $s \geq 3 \times h_{ef}$ and an edge distance $c \geq 1.5 \times h_{ef}$. Accurate data see ETA.

²⁾ The specified loads are valid for anchorages in dry and damp concrete. For temperatures in the anchoring substrate up to 50 °C (resp. short term up to 80 °C). Drill hole cleaning as per specification in the ETA. The factor Ψ_{sus} for sustained load was taken into account with 1.0.

³⁾ Further steel grades, versions and technical data see ETA, e.g. for dry internal conditions, galvanised steel (gvz); for damp interiors and for outdoor use, stainless steel (R).

⁴⁾ In the case of combinations of tensile and shear loads, bending moments with reduced or minimum spacing and edge distances (anchor groups), the design must be carried out in accordance with the provisions of the complete ETA and the provisions of the EN 1992-4:2018. We recommend using our anchor design software C-FIX.

Loads solid and perforated masonry

Injection system FIS V Plus with anchor rod FIS A in solid and perforated masonry										
Permissible loads ¹⁾²⁾ for a single anchor in masonry for pre-positioned installation. For the design the complete current assessment ETA-20/0729 has to be considered.										
Type	Compressive brick strength f_b [N/mm ²]	Brick raw density ρ [kg/dm ³]	Minimum brick dimensions ³⁾ (L x W x H) [mm]	Effective anchor-age depth h_{ef} [mm]	Minimum member thickness h_{min} [mm]	Maximum installation torque $T_{inst,max}$ [Nm]	Permissible tensile load ⁴⁾ N_{perm} [kN]	Permissible shear load ⁴⁾ V_{perm} [kN]	Minimum-spacing ⁵⁾ $s_{min} \parallel / s_{min,\perp}$ [mm]	Characteristic resp. minimum edge distance ⁶⁾ $c_{ef} = c_{min}$ [mm]
Solid brick Mz, NF, acc. to EN 771-1										
M6	≥ 12	≥ 1.8	240 x 115 x 71	≥ 50	115	4	1.14	0.71	240 / 75	100
M8	≥ 12	≥ 1.8	240 x 115 x 71	≥ 50	115	10	1.14	0.71	240 / 75	100
M10	≥ 12	≥ 1.8	240 x 115 x 71	80	115	10	1.42	1.14	240 / 75	100
M10	≥ 12	≥ 1.8	240 x 115 x 71	200	240	10	3.43	2.43	240 / 75	100
M12	≥ 12	≥ 1.8	240 x 115 x 71	80	115	10	1.57	1.14	240 / 75	100
M12	≥ 12	≥ 1.8	240 x 115 x 71	200	240	10	2.29	3.28	240 / 75	100
Solid sand-lime brick KS, acc. to EN 771-2										
M6	≥ 12	≥ 1.8	240 x 115 x 71	50	115	3	1.14	0.42	80 / 150	60
M6	≥ 12	≥ 1.8	240 x 115 x 71	100	115	3	1.57	0.89	80 / 300	60
M8	≥ 12	≥ 1.8	240 x 115 x 71	50	115	5	1.14	0.42	80 / 150	60
M8	≥ 12	≥ 1.8	240 x 115 x 71	100	115	5	2.29	0.89	80 / 300	60
M10	≥ 12	≥ 1.8	240 x 115 x 71	100	115	15	1.57	0.57	80 / 300	60
M10	≥ 12	≥ 1.8	240 x 115 x 71	200	240	15	3.42	0.57	80 / 600	60
M12	≥ 12	≥ 1.8	240 x 115 x 71	100	115	15	1.28	0.57	80 / 300	60
M12	≥ 12	≥ 1.8	240 x 115 x 71	200	240	15	3.42	0.57	80 / 600	60
M16	≥ 12	≥ 1.8	240 x 115 x 71	100	115	25	1.57	0.57	80 / 300	60
M16	≥ 12	≥ 1.8	240 x 115 x 71	200	240	25	3.42	0.57	80 / 600	60
Vertically perforated brick Hlz, acc. to EN 771-1³⁾										
M6 / M8 with FIS H 12 x 85 K	≥ 12	≥ 1.0	370 x 240 x 237	85	240	2	0.34	0.43	100 / 100	100
M8 / M10 with FIS H 16 x 130 K	≥ 12	≥ 1.0	370 x 240 x 237	130	240	2	0.86	0.57	100 / 100	100
M12 / M16 with FIS H 20 x 130 K	≥ 12	≥ 1.0	370 x 240 x 237	130	240	2	1.14	0.57	100 / 100	100
Perforated sand-lime brick KSL, acc. to EN 771-2³⁾										
M6 / M8 with FIS H 12 x 85 K	≥ 12	≥ 1.4	240 x 175 x 113	85	175	2	0.71	0.71	100 / 115	60
M8 / M10 with FIS H 16 x 130 K	≥ 12	≥ 1.4	240 x 175 x 113	130	175	2	1.00	1.29	100 / 115	80
M12 / M16 with FIS H 20 x 85 K	≥ 12	≥ 1.4	240 x 175 x 113	85	175	2	1.00	1.14	100 / 115	80
Lightweight concrete hollow block Hbl, acc. EN 771-3³⁾										
M6 / M8 with FIS H 12 x 85 K	≥ 2	≥ 1.0	362 x 240 x 240	85	240	2	0.43	0.26	100 / 240	60
M6 / M8 with FIS H 12 x 85 K	≥ 4	≥ 1.0	362 x 240 x 240	85	240	2	0.86	0.57	100 / 240	60
M8 / M10 with FIS H 16 x 85 K	≥ 2	≥ 1.0	362 x 240 x 240	85	240	2	0.43	0.26	100 / 240	60
M8 / M10 with FIS H 16 x 85 K	≥ 4	≥ 1.0	362 x 240 x 240	85	240	2	0.86	0.57	100 / 240	60
M12 / M16 with FIS H 20 x 200 K	≥ 2	≥ 1.0	362 x 240 x 240	200	240	2	0.71	0.26	100 / 240	60
M12 / M16 with FIS H 20 x 200 K	≥ 4	≥ 1.0	362 x 240 x 240	200	240	2	1.57	0.57	100 / 240	60
Aerated concrete acc. to EN 771-4⁶⁾										
M8	≥ 2	≥ 0.35	-	100	130	1	0.54	0.43	250 / 250	100
M8	≥ 4	≥ 0.50	-	200	230	8	1.07	0.71	80 / 80	100
M10	≥ 2	≥ 0.35	-	100	130	2	0.54	0.43	250 / 250	100
M10	≥ 4	≥ 0.50	-	200	230	12	1.79	0.71	80 / 80	100
M12	≥ 2	≥ 0.35	-	100	130	2	0.71	0.54	250 / 250	100
M12	≥ 4	≥ 0.50	-	200	230	16	1.79	0.71	80 / 80	100
M16	≥ 2	≥ 0.35	-	100	130	2	0.71	0.43	250 / 250	100
M16	≥ 4	≥ 0.50	-	200	230	20	1.79	0.71	80 / 80	100

¹⁾ The required partial safety factors for material resistance as well as a partial safety factor for load actions of $\gamma_L = 1.4$ are considered. Load values are valid for zinc-plated steel, stainless steel R and highly corrosion-resistant steel HCR. In perforated bricks and hollow blocks threaded rod FIS A in combination with anchor sleeve FIS H K.

²⁾ The given loads are valid for installation and use of fixations in dry masonry - use category d/d - for temperatures in the substrate up to 50 °C (resp. short term up to 80 °C) and drill hole cleaning according to assessment. The given brick types in combination with the permissible loads are an extract of the assessment.

³⁾ More information about, e.g. hole patterns, assortment of anchor sleeves FIS H K see assessment.

⁴⁾ In the case of combinations of tensile and shear loads, bending moments and reduced edge and axial spacings (anchor groups), the design must be carried out in accordance with the provisions of the complete assessment.

⁵⁾ Minimum feasible spacing resp. edge distance. Details as well as to the distances to joints see assessment.

⁶⁾ Cylindrical drill hole.



FiXperience. Safe and reliable.

The fischer design Software FiXperience gives you safe and reliable support in dimensioning your projects whether you are a planner, structural engineer or craftsman. FiXperience is set up modularly

and useable for a variety of applications. The program includes an engineering software with special application modules:



C-FIX
The anchor design program for steel and bonded anchor in concrete, as well as injection systems for masonry. Now with the new FEM design tool for the realistic design of anchorages.



MORTAR-FIX
To determine the injection resin volume for bonded anchors in concrete and masonry.



WOOD-FIX
For the calculation of on-rafter insulation systems and joints in structural timber engineering.



RAIL-FIX
For the design of fixings for railings on reinforced concrete slabs and staircases.



INSTALL-FIX
For the design and dimensioning of MEP installation systems.



FACADE-FIX
For the design of façade fixings with timber sub-structure.



REBAR-FIX
For the design of post-installed rebars in reinforced concrete.



CHANNEL-FIX
For the design of cast-in channels and inserts.



Electronic planner folder
All important documents and records from fischer in one program

Register on the [myfischer portal](#) to use **FiXperience online** or **download FiXperience** for free.

Dealer:

www.fischer-international.com



fischer stands for

Fixing Systems
Automotive
fischertechnik
Consulting
Electronic Solutions

fischerwerke GmbH & Co. KG
Klaus-Fischer-Straße 1 · 72178 Waldachtal
Germany
T +49 7443 12 - 0
www.fischer-international.com · info@fischer.de
